

XTS3000/XTS3500 Series

Parts List

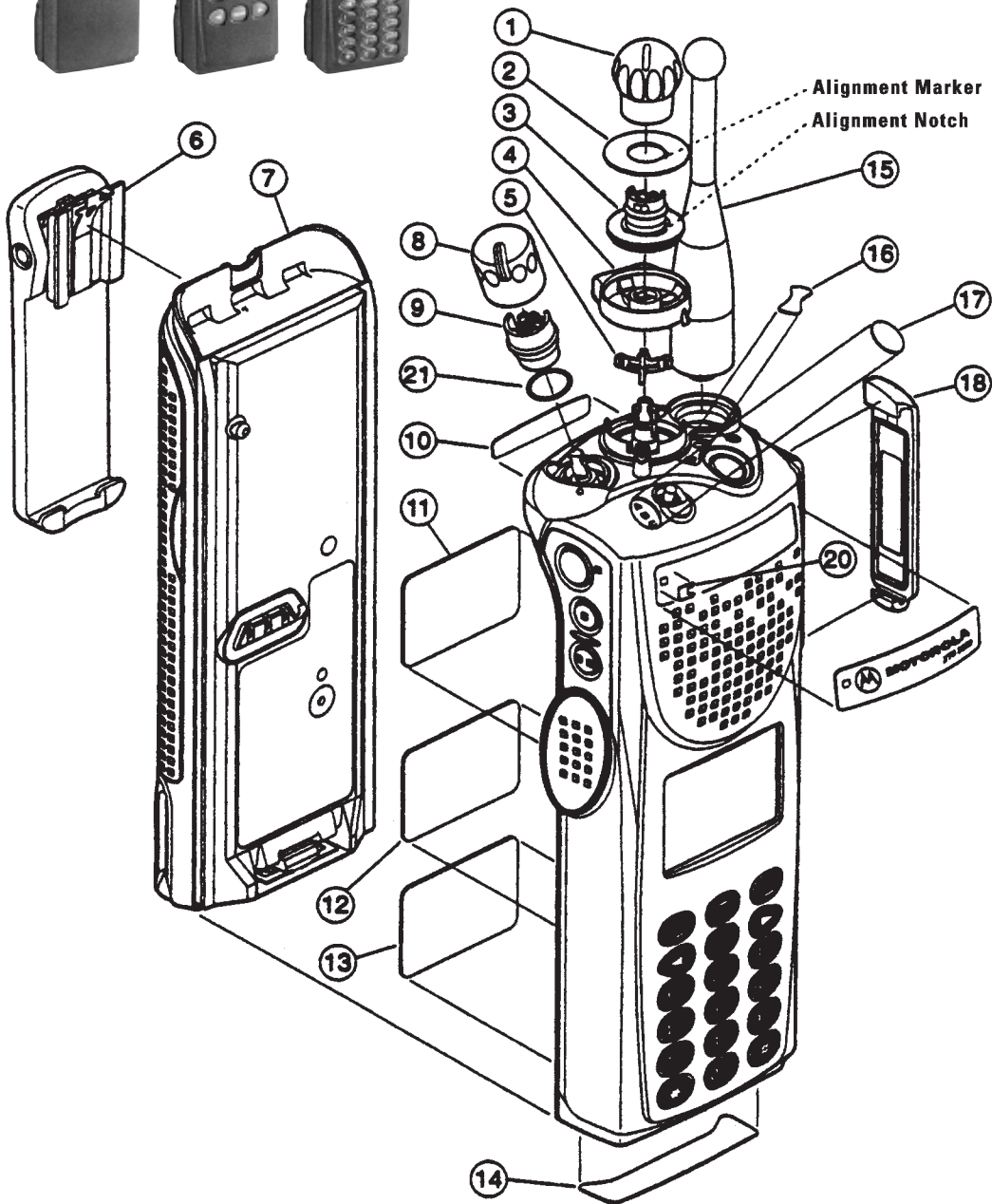

XTS3000/XTS3500 Series

Parts List

REF. NO.	PART NO.	DESCRIPTION	REF. NO.	PART NO.	DESCRIPTION
1	3605370Z01	Knob, Frequency	15	8505241U03	Antenna, 800 MHz Whip (806-870 MHz)
2	1305374Z01	Escutcheon, Frequency		or	
3	4305373Z01	Insert Retainer, Frequency		NAF4000B	Antenna, 800 MHz Dipole (806-870 MHz)
4	4505375Z01	Lever, Secure Frequency		or	
5	6105376Z01	Lightpipe Indicator/Stop, Frequency		8505241U06	Antenna, 800 MHz Stubby Quarterwave (806-870 MHz)
6	NTN8266B	Clip, Belt	16	----	Escutcheon, Concentric Switch (optional); not field repairable
7	NTN8294BR	Battery, NiCd	17	----	Escutcheon, Toggle (optional); not field repairable
8	3605371Z01	Knob, Volume	18	1505579Z01	Cover, Dust, Universal Connector
9	4305372Z01	Insert Retainer, Volume Knob	19	3305573Z01	Label, Motorola, Front
10	----	Label, Motorola, Back; not field repairable	20	3505586Z01	Gortex
11	----	Label, Flashport; not field repairable	21	3205379W01	"O" Ring
12	----	Label, Radio Serial number; not field repairable			
13	----	Label, Approval Agency; not field repairable			
14	----	Label, Bottom; not field repairable			

XTS3000/XTS3500 Series

Portable Accessories

Chargers

Single Unit Universal Tri-Chemistry Chargers

Tri-Chem chargers support Nickel Cadmium, Nickel Metal Hydride and Lithium-ion batteries.

NTN1667A Single Unit, universal tri-chem rapid charge, 110V

NTN1668A Single Unit, universal tri-chem rapid charge, 220V

NTN1669A Single Unit, universal tri-chem rapid charge, 240V

Multi-Unit Chargers



NTN1177D

Ideal charger for multi-shift operation or centrally located equipment rooms where spare batteries are always required. They can accommodate up to 6 batteries at once.

NTN1177D Multi-Unit, rapid rate, 110V (not for Lithium-ion)

NTN1178D Multi-Unit, rapid rate, 220V (not for Lithium-ion)

NTN1179D Multi-Unit, rapid rate, 240V (not for Lithium-ion)

Chargers

Motorola Conditioning Charger

The MCC will help extend battery life and enhance battery operation. It will safely condition and charge your specified Nickel Cadmium (NiCd) and Nickel Metal Hydride (NiMH) batteries in approximately an hour.

WPLN4086CR MCC Kit, 110V AC; includes both base unit and 7V adapter

WPLN4087CR MCC Kit, 220V AC; includes both base unit and 7V adapter

WPPN4021CR 7 Volt Adapter plate only

WPPN4065BR Multi-Unit Conditioning Charger Four-station Base, 110V; (order adapter plates separately)

3080384G15 Cigarette Lighter Adapter Cord

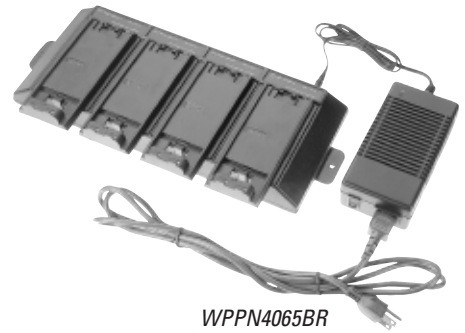

WPPN4065BR
Shown With Optional
Adapter Plates

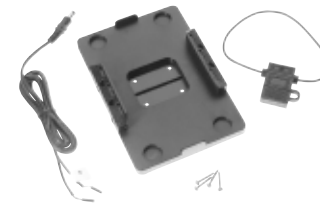

RLN4814A

RLN4814A Vehicular Mounting Bracket for single unit Motorola Conditioning Charger

3080384M21 DC Hard Wire Cable, for vehicular installation (included in RLN4814A)

3060665A04 120V Interchangeable line cord

XTS3000/XTS3500 Series

Portable Accessories

Chargers

Battery Maintenance System^{plus} (BMS^{plus})

Increase the useful life of your batteries.

Using interchangeable battery adapters (sold separately), the BMS^{plus} is capable of charging and discharging, analyzing, conditioning and cycle test on batteries; tracking battery voltage and capacity (mAh). The BMS^{plus} offers a 3 year warranty. Its easy-to-use design supports hundreds of 2-way, cellular and camcorder batteries with printer port* (Serial-RS-232C port – uses female 9-pin to male 25-pin cable).

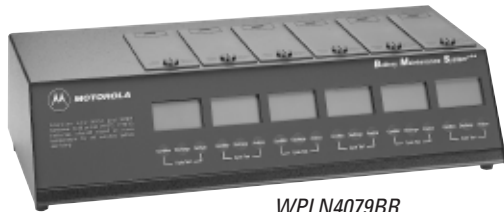

WPLN4079BR

WPLN4079BR Six-Station, 110V AC, 50/60 Hz

WPLN4080BR Six-Station, 230V AC, 50/60 Hz

WPPN4085AR BMS^{plus} field Upgrade Kit for WPLN4079AR, WPLN4080AR and WPLN4081AR; allows these units to support Li-ion battery chemistries

NDN4005B Three-Station, 110V AC 50/60 Hz (does not support Li-ion or 3-cell batteries)

NDN4006B Three-Station, 230V AC 50/60 Hz (does not support Li-ion or 3-cell batteries)

BMS^{plus} Adapters

WPPN4019AR Adapter, NiCd only

WPPN4022AR Adapter, NiCd and NiMH

WPPN4086AR Adapter; NiCd, NiMH and Li-ion

Chargers

Battery Optimizing System II (BOS II)



WPLN4124AR

No other battery analyzer matches the speed, accuracy, and versatility of the Battery Optimizing System II. Ideal for large fleet, public safety, and all other users who rely on their battery performance. Now with increased power, more sophisticated programming options, and easier to use navigation paths, optimizing your batteries was never easier. Key features include:

- Support for NiCd, NiMH, Li-ion, and SLA batteries
- 100 watt power supply and programmable from 100 mAh to 4 amps per station
- Interchangeable adapters accommodate all major brands
- Includes a variety of user programs and allows for customizable programming
- Proprietary recondition cycle restores NiCd and NiMH batteries
- Increased processing power and testing resolution – including a three minute Quicktest that measures the batteries State of Health (SoH)
- Printer output for reports and labels
- Three year warranty

WPLN4124AR BOS II, Four-Station, 100-240V AC (US line cord)

WPLN4125AR BOS II, Four-Station, 100-240V AC (UK/Euro line cords)

BOS II Adapter

RL-75765 Adapter, XTS3000

* Compatible with the STAR Micronics SP200 series printers, available from any STAR Micronics distributor, and other printers with STAR emulation.

XTS3000/XTS3500 Series

Portable Accessories

Chargers

impress™ Bundle Packs

Provide significant savings on the impress™ products by bundling a charger and batteries together as a Smart Energy System package.

RLN5263A impress Charger with two HNN9031AR batteries

RLN5262A impress Charger with two HNN9023AR batteries

RLN5441B impress Multi-Unit Charger with six HNN9032AR batteries

RLN5443B impress Multi-Unit Charger with six HNN9031AR batteries

RLN5486A impress Single-Unit Charger Bundle Includes 1 WPLN4111 impress charger and 2 NNTN4436AR Intrinsically Safe (FM) batteries. For XTS3000, XTS3500 and XTS5000 Two-way radios.

RLN5487A impress Single-Unit Charger Bundle Includes 1 WPLN4111 impress charger and 2 NNTN4437AR ruggedized batteries. For XTS3000, XTS3500 and XTS5000 Two-way radios.

RLN5489B impress multi-bundle XTS 1800 NiMH; Intrinsically Safe (Only with applicable Intrinsically Safe products)

RLN5490B impress multi-bundle XTS 1800 NiMH; Intrinsically Safe (Only with applicable Intrinsically Safe products)

impress™ Smart Energy System



WPLN4111AR

The impress™ smart energy system ensures maximum talk-time and optimized battery cycle life through the use of its advanced charging algorithm and automatic reconditioning features. The smart energy system reconditions impress batteries when they need it automatically, keeping them in peak condition. It's advanced conditioning features allow batteries to be safely left on

the charger for extended periods of time without incurring the damaging heat build-up which can rob batteries of cycle life. In addition, batteries left on the charger are kept fully charged so they are always ready when you need them. The impress system reconditions batteries when they need it based on their usage pattern. Talk time and cycle life are optimized and the need for manual maintenance programs reduced or eliminated. This rapid-rate tri-chemistry charging system will also charge existing legacy batteries and supports multiple radio platforms including Saber, XTS, and HT1000 series portables.

WPLN4111AR impress Smart Energy System Charger

WPLN4108BR impress Smart Energy System Multi-Unit Charger

Chargers

impress™ Multi-Unit Charger with Display Modules

The impress Multi-Unit Charger with Charger Display Modules has a two-line LCD screen for each of its six charger pockets that provides users with a host of valuable battery information. When a calibrated impress battery is inserted into a pocket, it provides the current battery mAh and percent of rated capacity which allows the user to immediately know the status of the battery without having to charge and discharge the battery. Additionally, the unit displays the remaining charge time (NiCd and NiMH only) which lets the user know when the impress battery will be ready for use. Additional information displayed includes: battery serial and part number information, battery chemistry, voltage, charge status and the version of the charger and display modules.

WPLN4130AR Multi-Unit Charger with Display Modules

RLN5382A Charger Display Module for impress multi-unit charger version 1.3 or later

RLN5591A Charger Display Module for impress multi-unit charger version 1.2 or earlier (Requires unit to be sent to the Rockford Service Center – instruction sheet provided)



WPLN4130AR

Vehicular Charger

This vehicular charger is a 12V DC that supports nickel cadmium (NiCd), nickel metal hydride (NiMH), and Lithium Ion (Li-ion) batteries for XTS3000, XTS3500 and XTS5000. A microprocessor senses the type of battery installed and controls the rate of charge accordingly. Batteries are charged at a rapid rate until fully charged at which point the unit reverts to a trickle charge. Batteries can be charged while on the radio or stand alone. The radio can be operated while in the charger and this unit is PAC RT compatible. The vehicular charger consists of a console, mounting hardware, and a supply cable.



NTN9176B Vehicular Charger

NTN9176B

XTS3000/XTS3500 Series

Portable Accessories

Chargers

Travel Charger

This compact Travel Charger mounts inside a vehicle for convenient battery charging throughout the workday, helping to assure users that they will never be out of touch due to lack of power. It has a voltage-regulated lighter adapter that plugs into the vehicle's socket, and includes a mounting bracket with nylon strap to hold the Two-way radio in place. Designed to charge batteries on or off the radio; users can use their radio while charging. A maintenance mode keeps batteries charged without damaging heat buildup, and the charging algorithm provides for cool charging of the battery. A recharge mode rapid charges batteries to compensate for capacity loss caused when radios are kept in receive or transmit mode.



RLN4884A

RLN4884B Travel charger

Vehicular Adapters

Allows customers to adapt XTS3000, XTS3500 and XTS5000 portables for mobile operation. Provides in-vehicle rapid and trickle charging for nickel cadmium (NiCd), nickel metal hydride (NiMH), and Lithium-ion (Li-ion) batteries. These units offer quick radio release and dead battery operation and are powered by attaching their supply cable to the 12V battery inside a police car, utility truck or other vehicle. Connectors are provided for the vehicle antenna, mobile microphone and optional amplified loudspeaker (HSN1000B). There is also a general interface connector for additional accessories. A color LED indicates battery recharge status. For XTVA operation, a microphone and RF switch (NTN8327A) are required. The required mobile microphone and optional loudspeaker allow for operation of the portable radio that is similar to that of a mobile.

NTN8561E XTS Vehicular Adapter, Closed Face, Mini-UHF

NTN8560E XTS Vehicular Adapter, Open Face with limited keypad access, Mini-UHF

NTN1607E XTS Vehicular Adapter, Closed Face, BNC

NTN1606E XTS Vehicular Adapter, Open Face with limited keypad access, BNC

Chargers

Adding accessories to the vehicular adapters requires one of the following two kits:

NTN8941A XTVA Data Cable Kit

NTN8943A XTVA Accessory Adapter Kit

Additional Accessories for the Vehicular Adapters

HMN4069E Standard White Palm Microphone

PLN7737B Hand Held Control Head

NTN8940B Trunnion (Required)

HSN1000B External Speaker Amplified, 6 Watts

HLN9330B Emergency Foot Switch

GLN7280A Emergency Pushbutton

6685687A01 Tool Wrench for RF Switch (Required)

NTN8327A RF Adapter (Required)

NKN6455A MTVA PA/Speaker Cable

XTS3000/XTS3500 Series

Portable Accessories

Carrying Accessories

Carrying Cases

A variety of carrying accessories are available for your comfort and convenience. The carrying cases are available in sizes designed to fit your radio & battery and permit audio to be heard clearly.

Model I Radios Only

NTN8387A Leather Carry Case with Belt Loop and T-Strap

NTN8385B High Activity Swivel Leather Carry Case with 2.5" Swivel Belt Loop and T-Strap

NTN8386B High Activity Swivel Leather Carry Case with 3.0" Swivel Belt Loop and T-Strap

NTN8725A High Activity Nylon Carry Case with Belt Loop and T-Strap



NTN8385B

Model II & III Radios Only



NTN8382B

NTN8382B Leather Carry Case with Belt Loop and T-Strap

NTN8380C High Activity Swivel Leather Carry Case with 2.5" Swivel Belt Loop and T-Strap



NTN8380C

NTN8381C High Activity Swivel Leather Carry Case with 3.0" Swivel Belt Loop and T-Strap Nylon Carry Case

NTN8725A High Activity Nylon Carry Case with Belt Loop and T-Strap

NTN9184A Leather Carry Case with Belt Loop for Clamshell Battery



NTN9184A

Carrying Accessories

Carrying Case Accessories

T-Straps

NTN8383A Leather T-Strap Plain Action Snap

NTN8384A Leather T-Strap Hard Action Snap

High Activity Belt Loops



NTN8039B

NTN8039B 2.5" Leather Swivel Belt Loop

NTN8040B 3.0" Leather Swivel Belt Loop



NTN8040B

NTN9179A High Activity Swivel 3.0" Belt Loop with "D" clip for battery

NTN9212A "D" clip for battery (for use with NTN9213A only)

NTN9213A 3.0" Belt Loop, High Activity

Belt Clips

NTN8266A Standard Removable Belt Clip Attachment

NTN8460A 3.0" Removable Belt Clip Attachment

Belt

4200865599 1.75" wide leather belt

Carrying Strap

NTN5243A Adjustable Black Carrying Strap; attaches to "D" ring on case

Chest Pack

HLN6602A Universal Chest Pack with Radio Holder, Pen Holder and Velcro Secured Pocket.

1505596Z02 Replacement Strap for HLN6602A



HLN6602A

XTS3000/XTS3500 Series

Portable Accessories

Carrying Accessories



RLN4570A

Break-a-Way Chest Pack

All of the same features as the original chest pack (HLN6602A) plus break-a-way tabs that allow the entire pack to be pulled off with approximately 10 lbs of pressure. Perfect for railroads, manufacturing locations, construction sites and anywhere that safety is a concern.

RLN4570A Break-A-Way Chest Pack



RLN4815A

RadioPAK™

It's different from all other holders or cases: more comfortable, more useful and more stylish. Worn around the waist, it holds two-way, iDEN portables or cellular phones right at hand. Includes a separate 6"x8" zippered pouch for other on-the-job necessities. Adjustable nylon weave belt; fits both men and women.

RLN4815A RadioPAK™ Radio/Utility Case

4280384F89 Universal RadioPAK™ Belt Lengthener; fits waists larger than 40"

Portable Radio Hanger

The portable radio hanger slides over and hangs from the door panel in a vehicle. The radio's belt clip slides onto the portable hanger allowing convenient, easy mounting. Two sizes are available to fit door panels.

TDN9327A Portable Radio Hanger for door panels up to 2-3/4"

TDN9373A Portable Radio Hanger for door panels 2-3/4" to 3-1/4"



TDN9327A

Audio Accessories

Remote Speaker Microphones (RSM)

Allows you to talk and listen without removing the radio from the belt, case or charger. Ideal for high noise level environments. These water resistant microphones include: coiled cord, 3.5mm earjack, swivel clothing clip, and quick disconnect latch.

***NMN6193C** Remote Speaker Microphone

***NMN6191C** Noise Canceling Remote Speaker Microphone

0104010J46 Replacement Coil Cord Cable Assembly for remote speaker microphones



NMN6193B

Public Safety Speaker/Microphones (PSM)

Public safety speaker microphones include straight cord assembly, 3.5mm earjack, swivel clip, quick disconnect latch, antenna connector, and receive audio high/low toggle switch. Antenna must be ordered separately. Use radio antennas on page XXX. Requires NTN8327A RF adapter.

***NMN6247A** Public Safety Microphone with Straight Cord, 30"; requires NTN8327A

***NMN6250A** Public Safety Microphone with Straight Cord, 24"; requires NTN8327A

***NMN6251A** Public Safety Microphone with Straight Cord, 18"; requires NTN8327A

***NTN8327A** RF Adapter; required for use with public safety microphone



NMN6247A

* Intrinsically safe

XTS3000/XTS3500 Series

Portable Accessories

Audio Accessories



XTS Series Commander™ Remote Speaker Microphone

The Commander Remote Speaker Microphone is enhanced with controls normally found only on the radio itself. You can take command of communication with a Push-to-Talk (PTT) Button, Emergency Button, Volume Control, 16-Channel Select Knob and 2 Programmable Buttons. This water resistant Remote Speaker Microphone also features a receive-

only 3.5mm earphone jack to allow for discrete conversations. What's more, the controls are specially designed for users who wear large gloves: the buttons are large, and the channel selector knob provides tactile feedback at each position. Compatible with XTS3000, XTS3500 and XTS5000 two-way radios. Intrinsically Safe (FM) when used with Intrinsically Safe XTS3000, XTS3500 and XTS5000 radios.

***RMN5021A** XTS Series Commander Remote Speaker Microphone

Receive-only Earpieces for Commander RSM

AARLN4885B Receive-only foam earpiece with 3.5mm adapter

RLN4941A Receive-only earpiece with 3.5mm plug, translucent tube and rubber eartip

WADN4190A Flexible Ear Receiver to be used with the Remote Speaker Microphone Public Safety Microphone

Epaulet Strap

Black leather epaulet strap secures remote speaker microphone to epaulet straps on shirt or jacket and accommodates back clip in leather cut-outs. Snap closure secures remote speaker microphone cord to allow reliable communications in hostile high movement applications.

RLN4294A Epaulet Strap, Velcro

RLN4295A Epaulet Strap, small clip



Audio Accessories

Surveillance Kits

Surveillance accessories allow the user to privately receive communications with the earpiece and are ideal when environments require discreet communications.

The following surveillance accessories require the BDN6676D (3.5 mm threaded adapter jack) that attaches to the radio.

Receive-only Surveillance Kit (1-Wire)

***BDN6664A** Beige

*†**BDN6665A** Beige

BDN6726A Black

†**BDN6727A** Black



BDN6664A

Receive-only Surveillance Kit with Volume Control (1-Wire)

***BDN6666A** Beige

BDN6728A Black



BDN6666A

* Intrinsically Safe
† Extra Loud Earphone (Exceeds OSHA Limits)

XTS3000/XTS3500 Series

Portable Accessories

Audio Accessories

Surveillance Kit with Microphone and Push-To-Talk Combined (2-Wire)

- *BDN6667A Beige
- *†BDN6669A Beige
- BDN6729A Black
- †BDN6731A Black



BDN6667A

Surveillance Kit with Microphone and Push-To-Talk Separate (3-Wire)

- *BDN6668A Beige
- *†BDN6670A Beige
- BDN6730A Black
- †BDN6732A Black



BDN6668A



BDN6676D

- *BDN6676D 3.5mm Jack Adapter with Quick Disconnect Latch

Audio Accessories

Surveillance Kit Accessories

5080369E38 Standard Earpiece Assembly (earphone, earloop, eartip), Beige

5080369E39 Extra Loud Earpiece Assembly (earphone, earloop, eartip), Beige

5080369E40 Plastic Urethane Earloop, Beige

5080369E41 Wire Earloop

5080371E69 Small Rubber Eartip, Pack of 25, Beige

5080371E71 Small Rubber Eartips, Pack of 25, Black

5080371E73 Standard Rubber Eartips, Pack of 25, Beige

5080371E75 Standard Rubber Eartips, Pack of 25, Black

5080369E90 Standard Earpiece Assembly (includes Earphone, Earloop, and Eartip), Black

5080370E91 Extra Loud Earpiece Assembly (includes Earphone, Earloop, and Eartip)

5080370E92 Earloop, Plastic, Black

5880377E06 Plastic Earloop Adapter



5080369E39

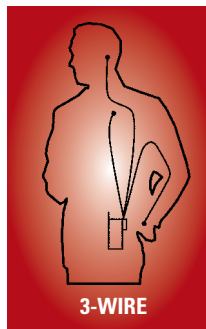
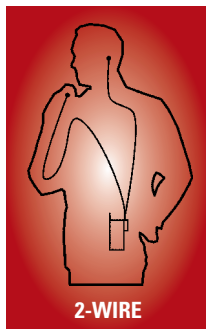
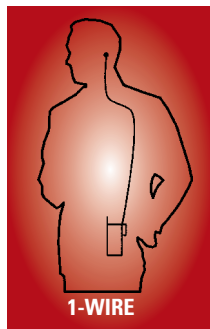

* Intrinsically Safe
† Extra Loud Earphone (Exceeds OSHA Limits)

XTS3000/XTS3500 Series

Portable Accessories

Audio Accessories

Completely Discreet Earpiece

Enables users to communicate with ease, in full privacy, without visible equipment. This miniaturized receiver is discreetly hidden in ear, where it fits comfortably for long periods at a time. Small as it is, it offers a full range of audio functions including automatic squelch, automatic gain control and noise filtering. Average battery life is approximately 100 hours and includes an end-of-life battery circuit generating a warning signal when the battery needs to be changed.



RLN4922A

Kit includes wireless receiver plus an inductive neckloop. Just remove the earpiece on any standard 2 or 3 wire Motorola surveillance kit (sold separately) and plug in the neckloop to use. Kit includes 6 spare batteries and 5 replacement ear wax guards.

RLN4922A Completely Discreet Earpiece Kit

Replacement Items

RLN4919A Ear Wax Guards, 5 per pack

RNN4005A 1.4 Volt Battery, 6 per pack

Noise Kits

Lightweight translucent tube attaches to Motorola surveillance accessories. Clothing clip prevents the accessory from being pulled from the ear due to body movement or head rotation.

NTN8370A Extreme Noise Kit, includes 2 foam earplugs for loud environments provides 24 dB noise protection.

NTN8371A Low Noise Kit, includes rubber eartip for low noise environments; does not provide hearing protection

5080384F72 Replacement Foam Plugs; pack of 50 (for use with NTN8370A)

5080371E73 Replacement Standard Rubber eartips, Pack of 25 (for use with NTN8371A), Beige



NTN8370A

Audio Accessories

Surveillance Kits with Extended-Wear Comfort Earpiece

These kits include a comfort earpiece with a rubber ear tip and a clear comfortable acoustic tube. Users hear transmissions clearly, while the clear tube provides a discreet appearance.

RLN5311A Comfort Earpiece with Microphone and PTT combined, Beige (2-wire kit)

RLN5312A Comfort Earpiece with Microphone and PTT combined, Black (2-wire kit)



RLN5311A

RLN5313A Receive-only Comfort Earpiece, Black

RLN5314A Receive-only Comfort Earpiece, Beige

Clear Comfortable Earpiece

The clear comfortable earpiece forms to the inside of your ear and is perfect for low noise environments. Compatible with the NTN8371A, clear acoustic tube assembly, and most surveillance kits (1-, 2- and 3-wire). This earpiece is made of easy-to-clean chemically inert, hypoallergenic material. Does not provide hearing protection. There are 3 items needed to make this product work:

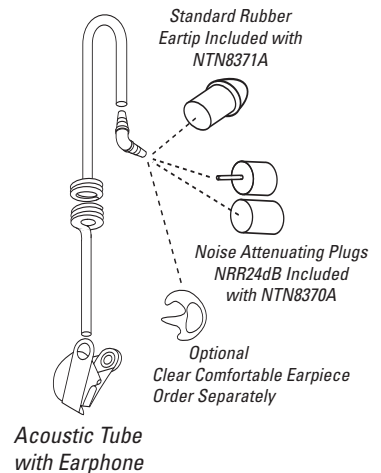

Acoustic Tube with Earphone

1. Clear Comfortable Earpiece
2. Clear Acoustic Tube Assembly (NTN8371A)
3. Surveillance Kits

RLN4760A Small Custom Earpiece, right ear

RLN4763A Small Custom Earpiece, left ear

RLN4761A Medium Custom Earpiece, right ear

RLN4764A Medium Custom Earpiece, left ear

RLN4762A Large Custom Earpiece, right ear

RLN4765A Large Custom Earpiece, left ear



RLN4760A



RLN4763A

XTS3000/XTS3500 Series

Portable Accessories

Audio Accessories

Ear Microphone System (EMS)

This compact unit picks up the voice through bone vibrations in the ear canal. The miniature earpiece leaves the hands free and face unobscured when worn by rescue and hazard protection personnel, who still retain the ability for direct hearing and speaking. For personnel required to wear breathing apparatus, communications with protective masks are as clear as communications without. And its high speech clarity under noisy environments makes it ideal for high noise environments. Available in PTT or Voice Activated (VOX).

Interface module needs to be ordered separately for EMS to work.

***BDN6677A** Ear Microphone for standard noise levels (up to 95dB), black

***BDN6678A** Ear Microphone for Standard Noise Levels (up to 95dB), beige

BDN6641A Ear Microphone for High Noise Levels (up to 105dB), grey



BDN6641A

Shown with Interface Module

Interface Modules For EMS

***BDN6708B** Push-To-Talk Interface Module

***BDN6671B** Push-To-Talk and Voice-Activated Interface Module

Optional Accessories for EMS

0180358B38 Remote Push-To-Talk Ring Switch

0180300E83 Remote Push-To-Talk Body Switch

0180300E25 Earguard with Adjustable Loop

0180358B32 Earholder, black, size small; secures ear mic in ear

0180358B33 Earholder, black, size medium; secures ear mic in ear

0180358B34 Earholder, black, size large; secures ear mic in ear



0180358B33

Audio Accessories

0180358B35 Earholder, clear, size small; secures ear mic in ear

0180358B36 Earholder, clear, size medium; secures ear mic in ear

0180358B37 Earholder, clear, size large; secures ear mic in ear

4280369E44 Replaceable Belt Clip with Screws

5080358B28 Eartips, black, size medium (10 per pack)

5080358B29 Eartips, black, size large (10 per pack)

5080358B30 Eartips, beige, size medium (10 per pack)

5080358B31 Eartips, beige, size large (10 per pack)

Flexible Ear Receiver



BDN6719A

The Flexible Ear Receiver contains a flexible earloop and speaker and rests external to the ear.

BDN6719A Ear Receiver with 3.5 mm Threaded Plug, requires BDN6676D adapter unless being used with speaker/microphone

7580372E11 Replacement Foam Ear Cushions for BDN6719A

Pellet Style Earpieces

BDN6780A Single Earbud with Microphone and Push-To-Talk. Requires BDN6676D adapter.

BDN6781A Single Earbud, receive only. Requires BDN6676D adapter

7580372E70 Replacement Foam Ear Cushion for Pellet Earpieces



BDN6780A

* Intrinsicly Safe

XTS3000/XTS3500 Series

Portable Accessories

Audio Accessories

CommPort: Integrated Microphone/Receiver System

The CommPort system contains a miniature microphone and receiver, and connects to your two-way radio, making it possible to hear and speak under the most adverse conditions.

***NTN1624A** Integrated Ear Microphone/Receiver System with Palm PTT (includes BDN6676 3.5mm jack adapter)



NTN1624A

***NTN1625A** Integrated Ear Microphone/Receiver System with PTT on Radio Adapter (includes BDN6676 3.5mm jack adapter)

***NTN1663A** Integrated Ear Microphone/Receiver System with Ring PTT (includes BDN6676 3.5mm Jack adapter)



NTN1663A

***NTN1736A** Integrated Ear Microphone/Receiver System with snap-on side PTT (includes BDN6676D radio adapter)

NNTN4186A Integrated Microphone/Receiver System with Remote Push-to-Talk Body Switch (includes BDN6676 3.5mm jack adapter)

NKN6510A Replacement Palm PTT Cable for NTN1624A

NKN6508A Replacement Cable for NTN1625A

NKN6512A Replacement Ring PTT Cable for NTN1663A

NKN6525A Replacement Snap-on PTT Cable for NTN1736A

Audio Accessories

NNTN4188A Replacement Remote Push-to-Talk Body Switch for NNTN4186A

NTN8821A CommPort Maintenance Kit, includes replacement ear tubes (quantity 10), windscreens (quantity 2) and microphone seal strips (quantity 10)

NTN8986A Adhesive Pads (Quantity 90) for secure attachment to ear

NTN8988A Ear Straps (Quantity 10) for secure attachment to ear

4285838B01 Replacement Collar Clip

4202006A01 Replacement Back Cover Clip

RLN5037A Replacement Ear Tubes (pack of 10)

Temple Transducer

The temple transducer represents a significant achievement in headset design and functionality. It allows the user to receive audio without covering the ear. The receiver portion of this accessory rests on the temples and is capable of converting the receive audio from a two-way radio into sound vibration. The sound vibration is transmitted through the surrounding human tissue and bone directly into the inner ear where it is received by the user. It features an in-line PTT and noise canceling boom microphone. The temple transducer enhances communication and safety by not impairing the user's hearing of external sound environment, such as from machinery and equipment, warning, and fire alarms, the intercom, traffic and even casual conversations with their co-workers.



RMN4049A

***RMN4049A** Temple Transducer

Lightweight Headsets

Lightweight headsets allow for high clarity, hands-free, discrete two-way communication, while adding comfort necessary for extended wear in moderate noise environments. Requires BDN6676D Audio Adapter.

NMN6246B Ultralite headset with boom microphone and in line push to talk switch, ear bud style

NMN6245A Single Muff Adjustable Lightweight Headset with Boom Microphone and In-line PTT

* Intrinsicly Safe

XTS3000/XTS3500 Series

Portable Accessories

Audio Accessories

Racing Headset for Two-Way Radios

Motorola is the official wireless equipment supplier of CART®, so whether your customers' playing field is a racetrack, construction site or other challenging environment, they can count on this Racing Headset for superior comfort and dependable operation.



RMN5015A

RMN5015A Racing headset for two-way radios (Adapter Cable required)

***BDN6673B** Adapter Cable for XTS2500, XTS3000, XTS3500 and XTS5000

Medium Weight Headsets

Medium weight headsets offer high-clarity sound with the additional hearing protection necessary for providing consistent, clear two-way radio communications in harsh, noisy situations.

NMN6258A Medium Weight Headset, over the head with In-Line PTT, noise reduction rating = 24dB

NMN6259A Medium Weight Headset, behind the head with In-Line PTT, noise reduction rating = 24dB

7580376E34 Replacement Foam Earseals, 1 pair

1580376E32 Replacement Cloth Covers for Earseals, 1 pair

5080548E02 Replacement Windscreen for Boom Microphone

3280376E35 Replacement O-ring for Windscreen

4204004K01 Replacement Adjustable Headstrap for NMN6259A



NMN6258A

Audio Accessories

Noise-Canceling Headsets with Boom Microphone

Ideal for two-way communication in extremely noisy environments. Dual-muff tactical headsets include two microphones on the outside of the earcups which reproduce the ambient sound back into the headset. Harmful sounds are suppressed to a safe level and low sounds are amplified up to 5 times the original level, but never more than 82dB(A). Includes on/off volume control on earcups and 3-foot curly cord. Easily replaceable earseals are filled with liquid and foam combination to provide excellent sealing and comfort. Requires separate in-line PTT adapter cable RKN4095A. Hardhat not included.

RMN4052A Tactical Headband Style Headset, grey; noise reduction rating of 24dB



RMN4052A



RMN4053A

RMN4053A Tactical Hardhat Mount Headset, grey; noise reduction rating of 22dB

Receive-only Headsets

Receive-only headsets are the right choice for high noise environments where users must hear information clearly, but seldom need to transmit. Dual muff headsets feature easily replaceable earseals filled with liquid and foam combination to provide excellent sealing and comfort.

RMN4056B Receive-only Dual Muff Headband-style Headset, provides 24 dB of noise reduction for use with all remote and public safety microphones with 3.5mm threaded jack (can be plugged directly into radio with BDN6676D adapter)

RMN4057B Receive-only Hardhat mounts easily to hardhats with slots and provides 22dB of noise reduction, for use with all remote and public safety microphones with 3.5mm threaded jack (can be plugged into radio with BDN6676D adapter)

* Intrinsically safe

XTS3000/XTS3500 Series

Portable Accessories

Audio Accessories

Hardhat Mount Headset with Noise-Canceling Boom Microphone

Ideal for two-way communication in high-noise environments; mounts easily to hardhats with slots, excellent noise reduction of 22dB. Easily replaceable earseals are filled with liquid and foam combination to provide excellent sealing and comfort. 3-foot curly cord assembly. Requires separate in-line PTT adapter cable RKN4095A. Hardhat not included.

RMN4051B Two-Way Hardhat Mount Headset, black



RMN4051B

Adapter Cables

RKN4095A In-Line PTT Adapter Cable. For use with RMN4051, RMN4052, and RMN4053.

Replacement Earseals for Headsets

RLN4923A Includes Two Replacement Snap-In Earseals; recommended replacement interval is once every six months to ensure constant level of attenuation, hygiene and comfort. For use with RMN4051, RMN4052, and RMN4053.

Audio Accessories

Heavyduty Headsets

Heavyduty headsets include noise-cancelling boom microphones and can be worn with or without a hardhat. Headsets are for use in noise levels up to 125 dB. The Push-To-Talk switch is located on the earcup. The VOX module is contained within the headset on voice activated units. **Heavyduty headsets require radio adapter cable BDN6673B to be ordered separately.**



BDN6645A

***BDN6645A** Push-To-Talk Headset with Boom Microphone; requires adapter cable BDN6673B; noise reduction rating =24dB



BDN6635B

***BDN6635B** Voice-activated Headset with Boom Microphone; requires adapter cable BDN6673B; noise reduction rating =24dB



BDN6636B

***BDN6636B** Voice-activated Headset with Throat Microphone; requires adapter cable BDN6673B; noise reduction rating =24dB

***BDN6673B** Radio Adapter Cable

* Intrinsicly Safe

XTS3000/XTS3500 Series

Batteries

Batteries

Nickel-Cadmium Premium

Part Number: **NTN8294BR**
 Volts: 7.5
 Avg mAh: 1525
 Height: 6-1/8"
 Intrinsically Safe: No

Part Number: **NTN8295AR**
 Volts: 7.5
 Avg mAh: 1525
 Height: 6-1/8"
 Intrinsically Safe: Yes

Part Number: **NTN8297AR**
 Volts: 7.5
 Avg mAh: 1525
 Height: 6-1/8"
 Intrinsically Safe: Yes
 Rugged: Yes



NTN8294BR

Nickel-Cadmium impres™

Part Number: **HNN9031AR**
 Volts: 7.5
 Avg mAh: 1525
 Height: 6-1/8"
 Intrinsically Safe: No

Part Number: **HNN9032AR**
 Volts: 7.5
 Avg mAh: 1525
 Height: 6-1/8"
 Intrinsically Safe: Yes

Nickel Metal Hydride impres™

Part Number: **NNTN4436AR**
 Volts: 7.5
 Avg. mAh: 2000 (1800 min)
 Height: 6-1/8"
 Intrinsically Safe: Yes

Part Number: **NNTN4437AR**
 Volts: 7.5
 Avg. mAh: 2000 (1800 min)
 Height: 6-1/8"
 Intrinsically Safe: Yes

Batteries

Nickel Metal Hydride Premium

Part Number: **NTN8299BR**
 Volts: 7.5
 Avg mAh: 1800
 Height: 6-1/8"
 Intrinsically Safe: Yes

Part Number: **NTN8923AR**
 Volts: 7.5
 Avg mAh: 1800
 Height: 6-1/8"
 Intrinsically Safe: No

Part Number: **RNN4007AR**
 Volts: 7.5
 Avg mAh: 3500
 Height: 6-1/8"
 Intrinsically Safe: Yes

Part Number: **RNN4006B**
 Volts: 7.5
 Avg mAh: 3500
 Height: 6-1/8"
 Intrinsically Safe: No



NTN8299BR

Lithium-ion Premium

Part Number: **NTN8610BR**
 Volts: 7.2
 Avg mAh: 1650
 Height: 6-1/8"
 Intrinsically Safe: No

Alkaline Premium Battery Shells

NTN9177A Disposable Battery Shell – Black

NTN9103A Disposable Battery Shell – Orange

XTS3000/XTS3500 Series

Antennas, Miscellaneous

Antennas

Flexible Whip Antenna

Flexible Whip antennas have a one-piece finish and steel core for optimal radiation characteristics. Provides more comfort when radio is worn on the belt.

8505241U05 Flexible Whip, 403-520MHz, 6"

8505241U03 Flexible Whip, 806-870MHz, 7"

8505241U05



Helical Antennas

Helical are sturdy and dependable for years of failsafe communication. Each antenna is designed and built to quality standards. The skirt at the base of the connector helps to seal out damaging elements. Connector is made of plated brass material for long life.

8505644V01 Helical, 136-151MHz, 6"

8505644V02 Helical, 151-162MHz, 6"

8505644V03 Helical, 162-174MHz, 6"

8505644V04 Helical, 403-435MHz, 3"

8505644V05 Helical, 435-470MHz, 3"

8505644V06 Helical, 470-520MHz 3"



8505644V01



8505644V03



8505644V04

Antennas

Dipole Antennas

Dipole molded antennas are injection molded in lasting polyurethane. The wide skirt at the bottom of the connector protects against damaging environmental elements. The dipole antenna is ideal when strong and solid signal clarity is demanded.

NAF4000B Dipole, 806-870MHz, 8"



NAF4000B

Wideband Antenna

Wideband antenna is ideal when radio is used in different frequencies since one antenna will cover all ranges.

8505518V01 Wideband, 136-174MHz, 6"

Stubby Antenna

This stubby quarterwave antenna is ideal when radio is worn on the belt because the short antenna is non-obtrusive.

8505241U06 Stubby, 806-941MHz, 4"; is a broad band antenna that operates in the 800/900MHz band



8505241U06

Miscellaneous

Public Safety Tilt Switch

NTN7660B Public Safety Tilt Switch. An external emergency switch that is activated when the unit is tilted at a greater than 60 degree angle. The emergency feature must be programmed in radio to enable the tilt position.

XTS3000/XTS3500 Series

Service Tools, Aids, Manuals

Service Tools

Battery Eliminator

The Battery Eliminator acts like a battery with a cable to access a DC external power supply.

REX4424A Battery Eliminator

Radio Interface Box

Links radio programming cable and computer interface together. Provides required voltage shift to enable communications between radio and computer. Requires computer interface cable, radio test and programming cable, and 9 volt snap type battery (6082728J01), order separately.

RLN4008E Radio Interface Box



RLN4008E



0180357A57

Wall Mounted Power Supply

Used to supply power to radio interface box, RLN4008E.

0180357A57 Wall Mounted Power Supply, 110 Volts

0180358A56 Wall Mounted Power Supply, 220 Volts

SMA to BNC Adapter

Make transmitter measurements while the portable is connected to the portable test set. The adapter connects the antenna jack. SMA and BMC adapter, adapts radio's antenna port to BNC cabling of test equipment.

5880384G68 SMA to BNC Adapter

Service Aids

Computer Interface Cable

Used to connect computer's serial port to Radio Interface Box.

3080369B71 Cable, RIB to 25 pin D

3080369B72 Cable, RIB to 9 pin D



3080369B71

Radio Test and Programming Cable

Used with Portable Radio Test Set, RTX4005B, for transmitter, receiver alignment and performance checks. Also used in programming radio.

RKN4035D Radio Test and Programming Cable

Probes

RT-5144/48/0 Needle-Fine Test Probes for High Density Circuitry (Black)

RT-5144/48/2 Needle-Fine Test Probes for High Density Circuitry (Red)

Manuals

6881074C70 VHF, UHF, 800MHz Radio Service Software Manual

6881083C70 I VHF, UHF, 800MHz User's Guide

6881083C75 II and VHF, UHF, 800MHz User's Guide

6881083C85 Basic Service Manual

6881083C90 Detailed Service Manual

6881090C63 II and VHF, UHF 800MHz user's guide

0180305J46 Ear Microphone System and Temple Transducer CD-ROM

0180305J70 impres™ System CD-ROM

Over 7 million customers have made MyRadioMall.com America's #1 choice when it comes to dependable and reliable Motorola Communications at fantastic prices.

We are now celebrating our 12th year of online service and the best is yet to come.



Advanced Radio Systems, Inc
8726 NW 26 Street #6
Miami, Florida 33172
Voice Numbers: 305-884-1795
Toll Free: 1-866-900-Mall (6255)
Fax Number: 305-884-1985

12/25/2006