

VISAR Series

Parts List

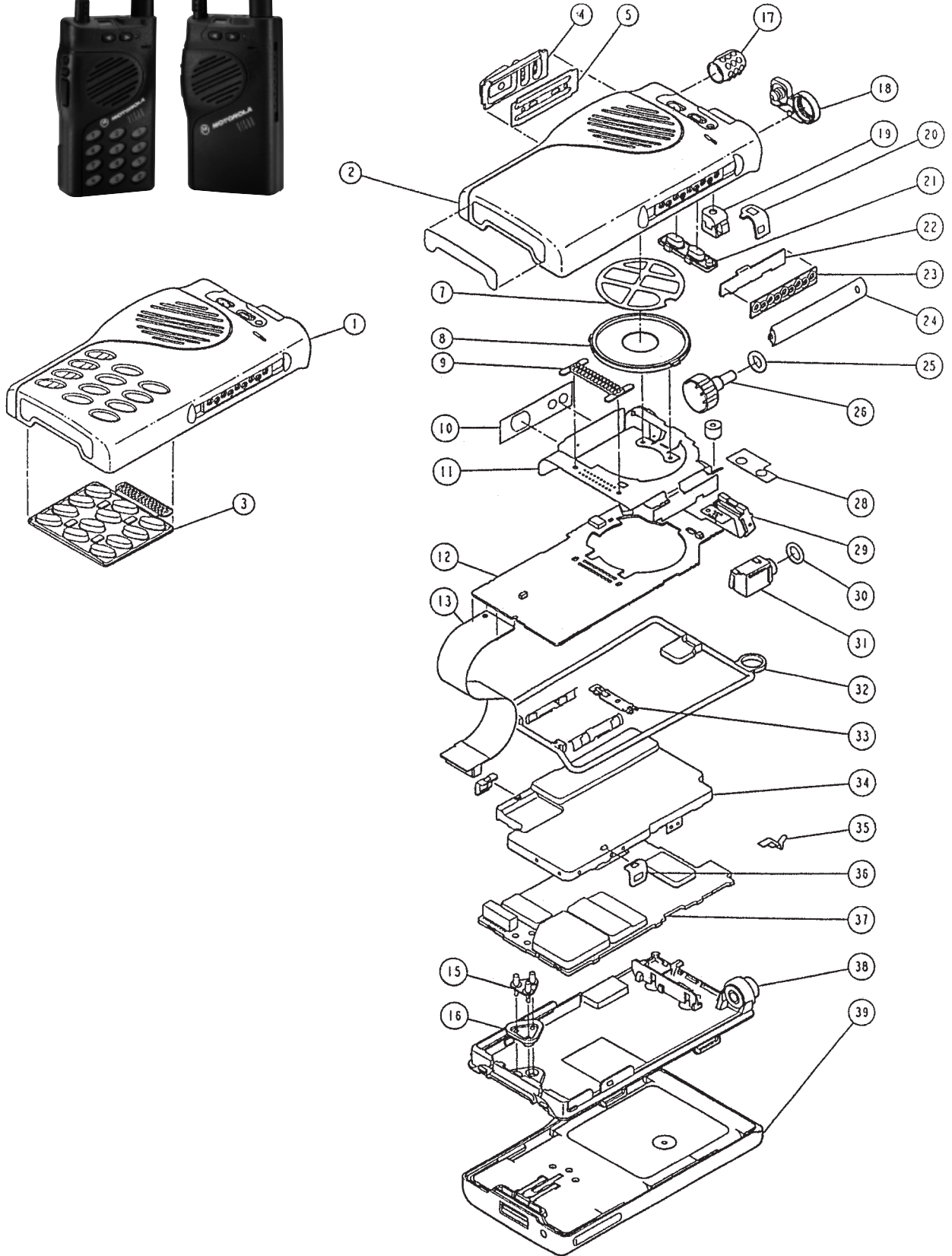

VISAR Series

Parts List

REF. NO.	PART NO.	DESCRIPTION
1	REX4402A	Cover, Front DTMF
1A*	REX4402A	Front Housing Replacement Kit
2	1505776Y01	Cover, Front Non-Keypad
3	7505541X01	Keypad, 12 Key
3A*	7505118X01	Keypad, 12 Key
4	7505585X01	Keypad, PTT
5	6405498X01	Plate, PTT
7	3505366W01	Screen, Speaker
8	5005256W01	Speaker
9	7505312Y01	Pad, Control Flex
9A*	3205634W01	Pad, Control Flex
10	3905530X01	Snapdome, Controls
11	8405768X02	Flex, Controls
12	----	Controller Board – not available
13	8405396W01	Flex, Interconnect
15	3905861X04	Contact, Battery Probe Assembly
16	3205119X01	Seal, Pogo
17	3605385W01	Knob, Volume
18	3885746A01	Dustcap, Jack
18A*	3885746A01	Dustcap, Jack
19	1405368W01	Boot, Microphone
20	3505384W01	Felt, Microphone

REF. NO.	PART NO.	DESCRIPTION
21	7505392W01	Keypad, Frequency
22	REX4044A	Assembly, Wedge Contact
24	3805110X01	Dustcap, Universal
25	3205379W01	Seal, Pot
26	1805642V01	Potentiometer, Volume
28	3905814X01	Snapdome, Frequency
	0180620D03	Frame, battery, Standard
29	5105279V98	Assembly, LCD
30	3205381W01	Seal, Jack
31	----	Jack – not available
32	----	“O” Ring, Main – not available
32A*	3205377W01	“O” Ring, Main
33	4205811X01	Clip, Printed Circuit Board
34	2605799X01	Shield, Main
35	3905912Y01	Contact, Antenna
36	4205378W01	Clip, Main Shield
37	----	Transceiver Board – not available
38	1505807Y05	Cover, Rear
38A*	1505371W01	Cover, Rear
39	----	Battery – not available

*AN models will show suffix at end of radio model number

VISAR Series



Portable Accessories

Chargers

Dual Unit Enhanced Desktop Chargers

The dual unit charger is designed to sequentially charge two batteries and can charge each battery in one to three hours. The charger will ship with a power cord. The charger is designed to operate with the use of interchangeable plug-in line cords. Additional line cords may be purchased separately.

NTN1402A Dual Unit Desktop Charger, Rapid Charge, 120V, with three step charging cycle

NTN1403A Dual Unit Desktop Charger, Rapid Charge, 220V, with three step charging cycle

NTN1404A Dual Unit Desktop Charger, Rapid Charge, 240V, with three step charging cycle

Charger Line Cords

The following charger line cords can be used on the dual unit rapid rate charger to provide versatility for worldwide charging capability.

3060665A04 120V Interchangeable Line Cord

3060665A05 220V Interchangeable Line Cord with 2-prong Euro Plug

3002120F02 240V Interchangeable Line Cord with 3-prong U.K. Plug



Six Pocket Charger

NTN7621D Six-Pocket Charger, Rapid Rate, 120V

NTN7622D Six-Pocket Charger, Rapid Rate, 220V, 2-prong Euro plug

NTN7623D Six-Pocket Charger, Rapid Rate, 240V, 3-prong U.K. plug

Vehicular Battery Eliminator

The battery eliminator saves useful battery life by drawing power from a vehicle's battery. Simply replace the portable battery with the battery eliminator and plug in the cigarette lighter adapter.

NDN4003A Vehicular Battery Eliminator



NDN4003A

Motorola Conditioning Charger (MCC)

Motorola Conditioning Charger (MCC)

The MCC utilize negative pulse charging technology that will help extend battery life and enhance battery operation. It will safely condition and charge your specified NiCd and NiMH batteries in approximately an hour. The MCC controls heat buildup due to its charging and termination algorithms and maintenance mode allows batteries to be safely left on the charger for extended periods of time. And now there is an Instant Fault Detection (IFD) feature which detects faulty radio batteries in seconds, which notifies the user that the battery will not operate at peak performance. Optional accessories are available allowing these chargers to be used in both AC and DC environments providing optimal charging flexibility.



WPPN4002BR
Shown With Optional
Cigarette Lighter Adapter

WPLN4100CR MCC Kit, 110V AC; includes both base unit and 7V adapter

WPLN4101BR MCC Kit, 220V AC; includes both base unit and 7V adapter

WPPN4002BR 110V AC Base Charge Unit Only (order adapter separately)

WPPN4006AR 220V AC Base Charge Unit Only (order adapter separately)

WPPN4065BR Multi-Unit Conditioning Charger, Four-Station Base, 110V (order adapter plates separately)

WPPN4003CR Adapter Only, 7V
3080384G15 Cigarette Lighter Adapter Cord

RLN4814A Vehicular Mounting Bracket for single unit Motorola Conditioning Charger

3080384M21 DC Hard Wire Cable, for vehicular installation (included in RLN4814A)

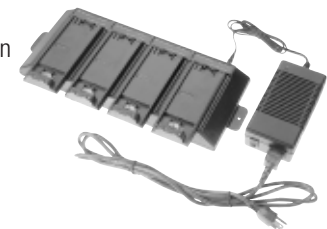

WPPN4065BR
Shown with adapter plates

VISAR Series

Portable Accessories

Battery Maintenance System^{plus} (BMS^{plus})

Increase the useful life of our batteries. Using interchangeable battery adapters (sold separately), the BMS^{plus} is capable of charging and discharging, analyzing, conditioning and cycle testing on NiCd, NiMH, Li-ion batteries; tracking battery voltage and capacity (mAh). The BMS^{plus} offers a 3-year warranty. Its easy-to-use design supports hundreds of 2-way, cellular, and camcorder batteries with printer port* (Serial-RS-232C port-uses female 9-pin to male 25-pin cable).

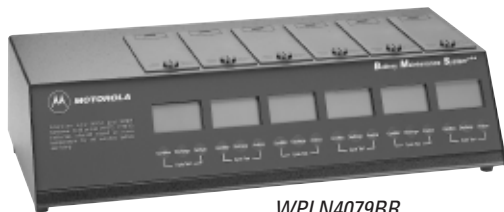

WPLN4079BR

WPLN4079BR Six-Station, 110V AC, 50/60 Hz

WPLN4080BR Six-Station, 230V AC, 50/60 Hz

WPPN4085AR BMSPlus field Upgrade Kit or WPLN4079AR and WPLN4080AR

NDN4005B Three-Station, 110V AC 50/60 Hz (does not support Li-ion or 3-cell batteries)

NDN4006B Three-Station, 230V AC 50/60 Hz (does not support Li-ion or 3-cell batteries)

BMS^{plus} Adapters

TDN9717A NiCd Battery Adapter, VISAR

CDN6141A NiMH Battery Adapter, VISAR

Battery Optimizing System II (BOS II)



WPLN4124AR

No other battery analyzer matches the speed, accuracy, and versatility of the Battery Optimizing System II. Ideal for large fleet, public safety, and all other users who rely on their battery performance. Now with increased power, more sophisticated programming options, and easier to use navigation paths, optimizing your batteries was never easier. Key features include:

- Support for NiCd, NiMH, Li-ion, and SLA batteries
- 100 watt power supply and programmable from 100 mAh to 4 amps per station
- Interchangeable adapters accommodate all major brands
- Includes a variety of user programs and allows for customizable programming
- Proprietary recondition cycle restores NiCd and NiMH batteries
- Increased processing power and testing resolution – including a three minute Quicktest that measures the batteries State of Health (SoH)
- Printer output for reports and labels
- Three year warranty

WPLN4124AR BOS II, Four-Station, 100-240V AC (US line cord)

WPLN4125AR BOS II, Four-Station, 100-240V AC (UK/Euro line cords)

BOS II Adapter

RL-73183 Standard Adapter, VISAR

* Compatible with the STAR Micronics SP200 series printers, available from any STAR Micronics distributor, and other printers with STAR emulation.

VISAR Series

Portable Accessories

Carrying Accessories

Carrying Cases

Full coverage carrying cases provide a convenient way to carry your radio while protecting it from the environment. There are cases that are designed to fit all VISAR radios and battery configurations. You may select from nylon or leather construction and a variety of other accessories.



NDN4010A

Carrying Cases for Medium Capacity batteries



TDN9659C

NDN4010A Hard Leather DTMF Carry Case with 2.5" Swivel Belt Loop

NDN4011A Hard Leather Carry Case with 2.5" Swivel Belt Loop

TDN9659C Soft Leather Carry Case with Belt Loop and Wrist Strap

TDN9657B Nylon Carry Case with Belt Loop



TDN9657C

Carrying Cases for High and Ultra High Capacity batteries



NDN4013A

NDN4012A Hard Leather DTMF Carry Case with 2.5" Swivel Belt Loop

NDN4013A Hard Leather Carry Case with 2.5" Swivel Belt Loop

TDN9660C Soft Leather Carry Case with Belt Loop and Wrist Strap

TDN9658B Nylon Carry Case with Belt Loop

Carry Holders

NTN7632A Plastic Carry Holder with 1-1/2" Belt Clip, fits all VISAR radios and battery configurations

NTN7633A Plastic Carry Holder with 2-1/2" Belt Clip, fits all VISAR radios and battery configurations



NTN7633A

Carrying Accessories

Carrying Accessories

TDN9675B Soft Leather Wrist Strap

4200865599 Black Leather Belt, 1.75"

4205638V09 Belt Clip, 2.5"

NTN5243A Adjustable Black Shoulder Carrying Strap, attaches to "D" rings on case

Swiveller Carrying System



TDN9684A

The swiveller secures your radio by locking into a belt mounted holster bracket. The swiveller keeps your radio secure while allowing it to swivel 360 degrees. The swiveller carrying system is available as a kit which consists of the nylon belt, holster, utility strap, and button configuration or sold separately.

TDN9684A Swiveller Kit, includes nylon belt, holster, utility strap, and clip button

TDN9687A Nylon Belt, 2" wide

TDN9688A Holster, compatible with all buttons

TDN9689A Utility Strap

TDN9690A Clip Button, mounts on carry holder

Miscellaneous Accessories

RLN4943A Universal Holder with Gooseneck Bracket; provides flexible mounting solutions for portable radios

RLN4945A Universal Holder with Gooseneck Bracket and Wheelchair Quick release assembly

RLN4944A Wheelchair Quick Release Bracket



RLN4943A

VISAR Series

Portable Accessories

Carrying Accessories

Chest Pack

HLN6602A Universal Chest Pack with Radio Holder, Pen Holder, and Velcro Secured Pouch

1505596Z02 Replacement Strap for HLN6602A



HLN6602A

Break-A-Way Chest Pack

All of the same features as the original chest pack (HLN6602A) plus break-a-way tabs that allow the entire pack to be pulled off with approximately 10 lbs. of pressure. Perfect for railroads, manufacturing locations, construction sites and anywhere safety is a concern.

RLN4570A Break-A-Way Chest Pack



RLN4815A

RadioPAK™

RLN4815A Universal RadioPAK™ with Radio Holder is worn around waist with adjustable belt (includes attached 6" by 8" zippered pouch for other job necessities)

4280384F89 Universal RadioPAK™ Belt Lengthener; fits waists larger than 40"

Portable Radio Hanger

The portable radio hanger slides over and hangs from the door panel in a vehicle. The radio's belt clip slides onto the portable hanger allowing convenient, easy mounting.

TDN9327A Hanger, fits door panels up to 2-3/4" wide

TDN9373A Hanger, fits door panels 2-3/4" to 3-1/4" wide



TDN9327A

Audio Accessories

Remote Speaker Microphone (RSM)



NMN6196A

The remote speaker microphone is a water-resistant compact unit that allows the user to talk and listen without removing the radio from the belt, case or charger. It has a coiled cord, push-to-talk switch and clothing clip on the back cover.

***NMN6196A**

Remote Speaker Microphone

RSM Accessories

Epaulet Strap

Black leather epaulet straps secure remote speaker microphones to epaulet of shirts or jackets and attach around cord to back of microphone.

RLN4294A Epaulet Strap, Velcro

RLN4295A Epaulet Strap, small clip



RLN4295A

MicJackets

MicJackets provide speaker microphone users with a way to further protect the "head" of their microphone from dust, dirt, metal particles, sweat, body oils and other on-the-job grime; MicJackets also allow the user to handle or interact with the speaker microphone in a more hygienic way.

RLN4903A Micjacket, compatible with NMN6196A remote speaker microphone

* Intrinsicly Safe

VISAR Series

Portable Accessories

Audio Accessories

Surveillance Accessories

Surveillance accessories allow the user to privately receive communications with the earpieces and are ideal when environments require discreet communications. The following 3.5 mm threaded surveillance accessories plug directly into the top of the radio. No additional adapter is required.

Receive-only Surveillance Kit (1-Wire)

- *BDN6664A Beige
- *†BDN6665A Beige
- *BDN6726A Black
- *†BDN6727A Black



BDN6664A



BDN6666A

Receive-only Surveillance Kit with Volume Control (1-Wire)

- *BDN6666A Beige
- *BDN6728A Black



BDN6667A

Surveillance Kit with Microphone and Push-To-Talk Combined (2-Wire)

- *BDN6667A Beige
- *†BDN6669A Beige
- *BDN6729A Black
- *†BDN6731A Black



BDN6668A

Surveillance Kit with Microphone and Push-To-Talk Separate (3-Wire)

- *BDN6668A Beige
- *†BDN6670A Beige
- *BDN6730A Black
- *†BDN6732A Black

Audio Accessories

Surveillance Kit Replacement Accessories

5080369E38 Standard Earpiece Assembly, includes earphone, earloop and eartip, beige

5080370E90 Standard Earpiece Assembly includes earphone, earloop and eartip, black

5080369E39 Extra Loud Assembly, includes earphone, earloop and eartip, beige

5080370E91 Extra Loud Earpiece Assembly, includes earphone, earloop and eartip, black



5080369E39



5080370E92

5080369E40

Plastic Urethane Earloop, beige

5080370E92

Plastic Urethane Earloop, black

5080371E69 Small Rubber Eartip, beige, pack of 25

5080371E71 Small Rubber Eartip, black, pack of 25

5080371E73 Standard Rubber Eartip, beige, pack of 25

5080371E75 Standard Rubber Eartip, black, pack of 25

5880377E06 Plastic Eartip Adapter, pack of 10

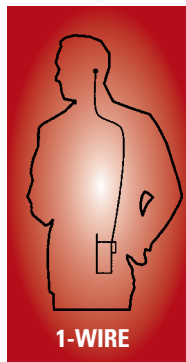

1-WIRE



2-WIRE

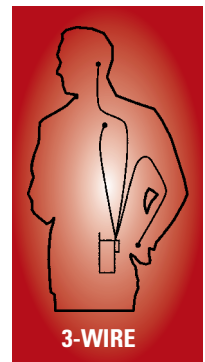

3-WIRE

* Intrinsically Safe

*† Extra Loud Earphone (Exceeds OSHA limits)

VISAR Series

Portable Accessories

Audio Accessories

Completely Discreet Earpiece

Remain discreetly in touch with this miniaturized receiver. All messages received through the user's two-way radio are inductively relayed to the wireless earpiece in the user's ear. Inductive neckloop is easily hidden under the user's clothing for covert operations. Neckloop attaches to the user's Motorola Surveillance Kit providing completely discreet two-way communications. Security operatives, public safety officials, and private investigators can communicate with ease without any visible equipment. Small as it is, it offers a full range of audio functions including automatic squelch, automatic gain control and noise filtering. Must be used in conjunction with a Motorola Surveillance Kit. Just remove the earpiece on any standard 2- or 3-wire surveillance kit and plug in the neckloop for completely discreet communication.

RLN4922A Completely Discreet Earpiece Kit; includes wireless earpiece, inductive neckloop, 6 spare batteries and 5 spare ear wax guards

RLN4919A Ear Wax Guards, 5 per pack

RNN4005A 1.4V Battery, 6 per pack



RLN4922A

Audio Accessories

Noise Kits

Lightweight translucent tube attaches to Motorola surveillance accessories. Clothing clip prevents the accessory from being pulled from the ear due to body movement or head rotation.

NTN8370A Extreme Noise Kit, includes 2 foam earplugs for loud environments; provides 24dB noise protection

NTN8371A Low Noise Kit, includes rubber eartip for low noise environments

5080384F72 Replacement Foam Plugs, pack of 50 (for use with NTN8370A)

5080371E73 Beige Replacement Standard Rubber Eartips; for use with NTN8371A, (pack of 25)

5080371E75 Black Replacement Standard Rubber Eartips; for use with NTN8371A, (pack of 25)



NTN8370A

Clear Comfortable Earpiece

The clear comfortable earpiece forms to the inside of your ear and is perfect for low noise environments. Compatible with the NTN8371A, clear acoustic tube assembly, and most surveillance kits (1-, 2- and 3-wire). This earpiece is made of easy-to-clean chemically inert, hypoallergenic material. There are 3 items needed to make this product work:

1. Clear Comfortable Earpiece
2. Clear Acoustic Tube Assembly (NTN8371A)
3. Surveillance Kits

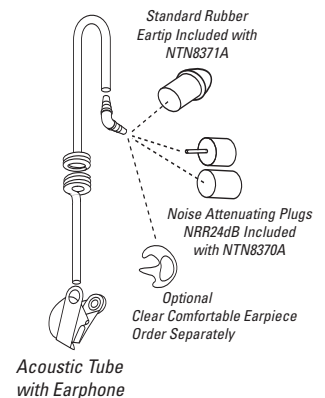

RLN4760A Small Custom Earpiece, right ear

RLN4763A Small Custom Earpiece, left ear

RLN4761A Medium Custom Earpiece, right ear

RLN4764A Medium Custom Earpiece, left ear

RLN4762A Large Custom Earpiece, right ear

RLN4765A Large Custom Earpiece, left ear

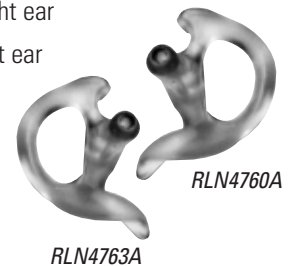

RLN4760A

RLN4763A

VISAR Series

Portable Accessories

Audio Accessories

Flexible Ear Receiver

The flexible ear receiver is ideal for situations where ambient noise can distract radio communications. It has an adjustable rubberized earloop that can be worn on either ear for maximum comfort. The durable cable with strain relief provides enhanced sound quality and reception. No additional adapter is required.

BDN6719A Flexible Ear Receiver with 3.5mm Threaded Plug, black with foam ear cushion

7580372E11 Foam Ear Cushion for BDN6719A



BDN6719A

Pellet Style Earpieces



BDN6780A

The pellet style earpiece allows the user to receive communication discreetly and is comfortable for extended wear.

BDN6780A Single Earbud with Microphone and PTT

BDN6781A Single Earbud, receive only, black

7580372E70 Replacement Foam Ear Cushion for Pellet Earpieces

Audio Accessories

Ear Microphone System (EMS)

This compact unit picks up the voice through bone vibrations in the ear canal. The miniature earpiece leaves the hands free and face unobscured when worn by rescue and hazard protection personnel, who still retain the ability for direct hearing and speaking. For personnel required to wear breathing apparatus, communications with protective masks are as clear as communications without. And its high speech clarity under noisy environments makes it ideal for high noise environments. Available in PTT or Voice Activated (VOX). Interface module needs to be ordered separately for EMS to work.

BDN6768A Ear Microphone, for standard noise levels up to 95dB, black

BDN6769A Ear Microphone, for standard noise levels up to 95dB, beige

BDN6770A Ear Microphone, for high noise levels up to 105dB, gray



BDN6768A

Interface Modules

BDN6771A Push-to-Talk Only Interface Module

BDN6779A Voice Activated Transmit and Push-To-Talk



BDN6779A

VISAR Series

Portable Accessories

Audio Accessories

Optional Accessories (EMS)

0180358B38 Remote Push-To-Talk Ring Switch

0180300E83 Remote Push-To-Talk Body Switch

0180300E25 Earguard with Adjustable Loop; secures ear mic in ear



0180358B38



0180358B33

0180358B32 Earholder, black, size small; secures ear mic in ear

0180358B33 Earholder, black, size medium; secures ear mic in ear

0180358B34 Earholder, black, size large; secures ear mic in ear

0180358B35 Earholder, clear, size small; secures ear mic in ear

0180358B36 Earholder, clear, size medium; secures ear mic in ear

0180358B37 Earholder, clear, size large; secures ear mic in ear

4280369E44 Replaceable Belt Clip with Screws

5080358B28 Eartips, black, size medium (10 per pack)

5080358B29 Eartips, black, size large (10 per pack)

5080358B30 Eartips, beige, size medium (10 per pack)

5080358B31 Eartips, beige, size large (10 per pack)

Audio Accessories

Lightweight Headsets

Lightweight headsets allow for high-clarity, hands free, discreet two-way communications while adding comfort necessary for extended wear in moderate-noise environments. No adapter required.

***NMN6245A** Single Speaker Lightweight Headset with In-Line Push-To-Talk Switch

NMN6246B Ultralite Headset with Boom Microphone and In-Line Push-To-Talk Switch, ear bud style receiver

REX4648A Replacement Foam Earpad and Windscreen Kit for NMN6245A

5080574E02 Foam Ear Pads for NMN6245A, 10 per package

5080550E03 Headset Ear Rest

5080550E04 Headset Microphone Windscreen



NMN6246B

* Intrinsicly Safe

VISAR Series

Portable Accessories

Audio Accessories

Medium Weight Headsets

Medium weight headsets offer high-clarity sound with the additional hearing protection necessary for providing consistent, clear two-way radio communications in harsh, noisy situations.

NMN6260A Medium Weight, Over-the-Head Dual Muff Headset with Inline PTT Switch; headset provides 24dB of noise reduction

NMN6261A Medium Weight, Behind-the-Head Dual Muff Headset with Inline PTT Switch; headset provides 24 dB of noise reduction; can be worn with hardhat



NMN6260A



NMN6261A

7580376E34 Replacement Foam Earseals, 1 pair

1580376E32 Replacement Cloth Covers for Earseals, 1 pair

5080548E02 Replacement Windscreen for Boom Microphone

3280376E35 Replacement O-ring for Windscreen

4204004K01 Replacement Adjustable Headstrap for NMN6261A

Receive Only Headsets

Receive only headsets are the right choice for high noise environments where users must hear information clearly, but seldom need to transmit. Dual muff headsets feature easily replaceable earseals filled with liquid and foam combination to provide excellent sealing and comfort.

RMN4056B Receive only dual muff headband style headset, provides 24 dB of noise reduction for use with a 3.5mm threaded jack (can be plugged directly into radio with BDN6676D adapter)

RMN4057B Receive only hardhat mounts easily to hardhats with slots and provides 22dB of noise reduction, for use with all remote and public safety microphones with 3.5mm threaded jack (can be plugged into radio with BDN6676D adapter)

Audio Accessories

Heavy Duty Headsets

Heavy duty headsets include noise-cancelling microphones and can be worn with or without a hardhat. Headsets are for use in noise levels up to 125 dB. The Push-to-Talk switch is located on the earcup. The VOX module is contained within the headset on voice activated units. Heavy duty headsets require radio adapter cable. Provides 24dB of noise reduction.

***BDN6645A** Push-to-Talk Headset with Boom Microphone; requires adapter cable BDN6772A



BDN6645A



BDN6635B

***BDN6635B** Voice-Activated Headset with Boom Microphone; requires adapter cable BDN6772A

***BDN6636B** Voice-Activated Headset with Throat Microphone; requires adapter cable BDN6772A

***BDN6772A** Radio Adapter Cable



BDN6636B

* Intrinsicly Safe

VISAR Series

Portable Accessories, Antennas

Replacement Kits

REX4399A VISAR DTMF Cosmetic Replacement Kit, includes DTMF Front Cover, Volume Knob, Dust Cap, 12-Key Keypad, Frequency Keypad, and PTT Keypad

REX4400A VISAR Cosmetic Replacement Kit, includes Front Cover, Volume Knob, Dust Cap, Audio Jack Dust Cap, Frequency Keypad, and PTT Keypad

REX4380A VISAR Knob/Seal Replacement Kit, includes Volume Knob, Dust Cap, and Audio Jack Dust Cap

REX4417A VISAR side connector piece part kit, includes housing, clip PCB (printed circuit board) with pogo pins, base plate and base plate seal



REX4399A

Antennas

Helical Antennas

Helical are sturdy and dependable for years of failsafe communication. Each antenna is designed and built to quality standards. The skirt at the base of the connector helps to seal out damaging elements. Connector is made of plated brass material for long life.

8505834W01 Helical, 136-150.8MHz, 5"

8505834W02 Helical, 150.8-178MHz, 5"

8505834W03 Helical, 162-178MHz, 5"

8505644V01 Helical, 136-151MHz, 6"

8505644V02 Helical, 151-162MHz, 6"

8505644V03 Helical, 162-174MHz, 6"

8505644V04 Helical, 403-435MHz, 3"

8505644V05 Helical, 435-470MHz, 3"

8505644V06 Helical, 470-520MHz 3"



8505834W02



8505644V04

Flexible Whip Antenna

Flexible whip antennas have a one-piece finish and steel core for optimal radiation characteristics. Provides more comfort when the radio is worn on the belt.

8505241U05

Flexible Whip, 403-520MHz, 6"

8505241U03

Flexible Whip, 806-870MHz, 7"



8505241U05

Stubby Antenna

This stubby quarterwave antenna is ideal when radio is worn on the belt because the short antenna is non-obtrusive.

***8505241U06**

Stubby, 806-941MHz, 4"



8505241U06

* 8505241U06 is a broad band antenna that operates in the 800/900MHz band

VISAR Series

Batteries, Service Aids

Batteries

Nickel-Cadmium Premium

Part Number: **NTN7395BR**
 Volts: 7.5
 Avg. mAh: 1200
 Height: 4"
 Intrinsically Safe: No



NTN7395BR

Part Number: **NTN7398BR**
 Volts: 7.5
 Avg. mAh: 1200
 Height: 4"
 Intrinsically Safe: Yes



NTN7398BR

Nickel Metal Hydride Premium

Part Number: **NTN7394CR**
 Volts: 7.5
 Avg. mAh: 1300
 Height: 4"
 Intrinsically Safe: No

Part Number: **NTN7396BR**
 Volts: 7.5
 Avg. mAh: 600
 Height: 4"
 Intrinsically Safe: No

Part Number: **NTN7397CR**
 Volts: 7.5
 Avg. mAh: 1300
 Height: 4"
 Intrinsically Safe: Yes



NTN7397CR

Service Aids

Computer Interface Cable

Used to connect computer's serial port to Radio Interface Box.

3080369B71 Computer Interface Cable; RIB to 25 pin D

3080369B72 Computer Interface Cable; RIB to 9 pin D

Radio Interface Box

Links radio programming cable and computer interface together. Provides required voltage shift to enable communications between radio and computer. Requires computer interface cable, radio programming cable and a 9 volt snap type battery (6082728J01) or wall mount power supply; order separately.



RLN4008E

RLN4008E Radio Interface Box (RIB)

Wall Mounted Power Supply

Used to supply power to Radio Interface Box.

0180357A57 Wall Mounted Power Supply (110 volts)

0180358A56 Wall Mounted Power Supply (220 volts)



0180357A57

VISAR Series

Service Aids, Manuals

Service Aids

Program/Test Cable

Acts as a link between RIB and radio; required to program radio.

3080371E46 Program/Test Cable

Shop Battery Eliminator

RLN4327A Shop Battery Eliminator; connects radio to bench power supply for testing



SMA to BNC Adapter

5880384G68 SMA to BNC Adapter; adapts radio's antenna port to BNC cabling of test equipment

5880384G68

Portable Test Set

RLN4460C Portable Test Set; enables connection to the universal connector

Field Modification Kit

RPX4665A Field Modification Kit; allows switching for radio testing

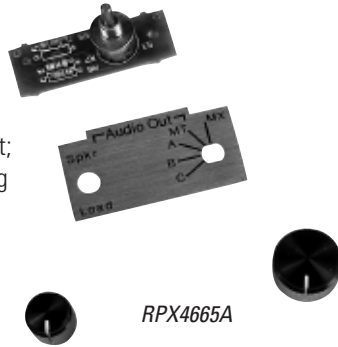

RPX4665A

Service Aids

Cloning Cable

RKN4043A Cloning Cable; allows a radio to be duplicated from a master radio by transferring programmed data from one radio to another

Programming Software

This software enables you to add or reprogram frequencies as your requirements change. Requires Radio Interface Box and proper cables; order separately.

RVN4123G PRIVACY PLUS Programming Software, includes 3-1/2" diskette, manual, binder, and storage box

RVN4098H Conventional Programming Software; includes 3-1/2" diskette, manual, binder, and storage box

Manuals

6881073C75 Service and Theory Manual

6881073C70 Operator Manual, Conventional

Over 7 million customers have made MyRadioMall.com America's #1 choice when it comes to dependable and reliable Motorola Communications at fantastic prices.

We are now celebrating our 12th year of online service and the best is yet to come.



Advanced Radio Systems, Inc
8726 NW 26 Street #6
Miami, Florida 33172
Voice Numbers: 305-884-1795
Toll Free: 1-866-900-Mall (6255)
Fax Number: 305-884-1985

12/25/2006