

LTS2000 Series

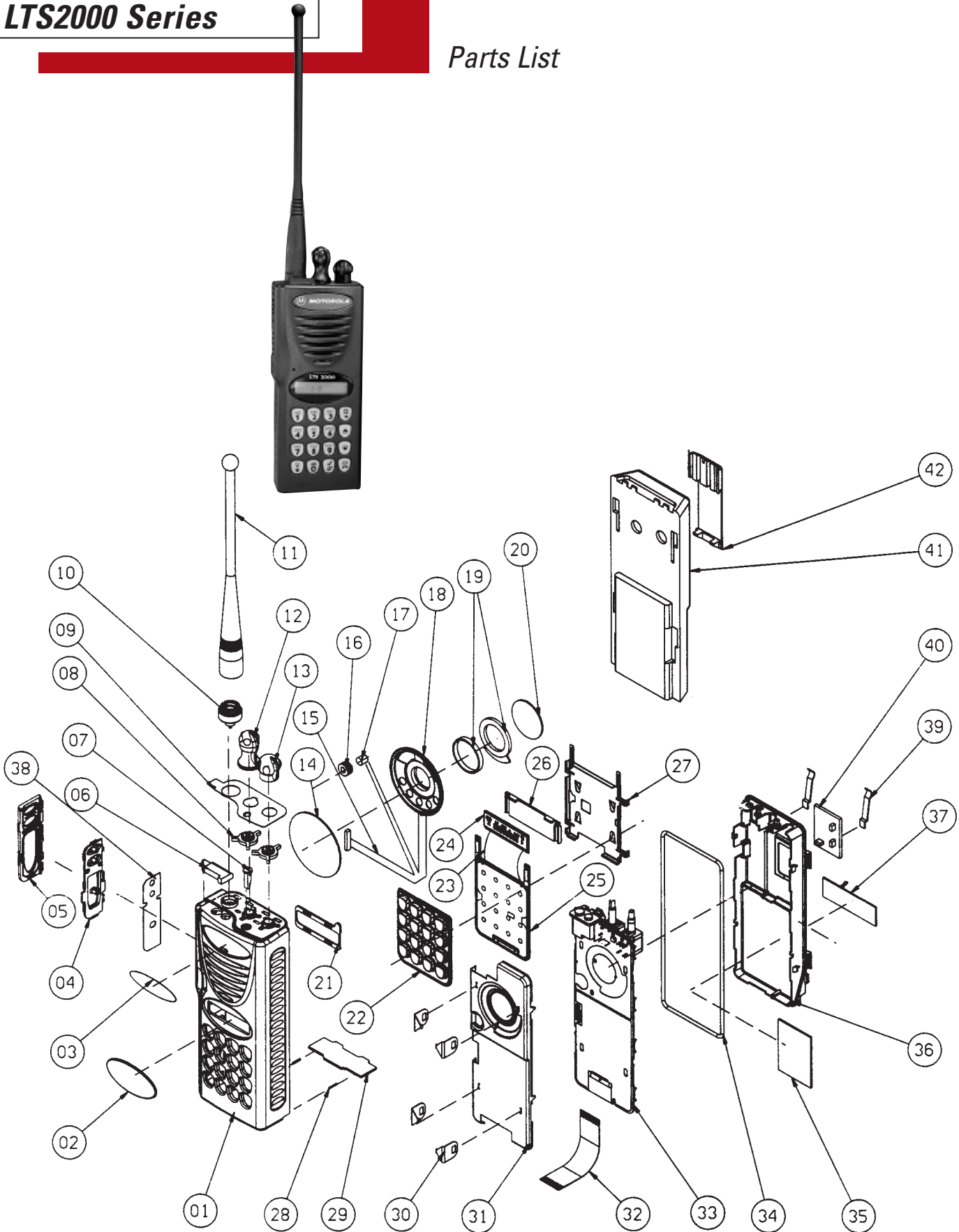

Parts List



LTS2000 Series

Parts List

REF. NO.	PART NO.	DESCRIPTION
1	1580422K02	Front Housing
2	---	LCD Cover, part of 1580422K02 (cannot be ordered separately)
3	3380455K01	Name Plate
4	7580430K01	PTT Keypad
5	1380431K01	PTT Bezel
6	3880428C02	Dust Cap
7	6180687K01	Light Pipe
8	3280960Y01	Seal, 2 used
9	1380463K01	Escutcheon
10	5880636V01	Antenna Adapter
11	8505241U03	Antenna Whip
12	3680433K01	Frequency Knob
13	3680432K01	Volume Knob
14	3580998Z04	Speaker Felt
15	3080560D01	Speaker/Mic Cable
16	1480577C01	Microphone Boot
17	5013920A03	Microphone
18	5005589U05	Speaker
19	7580506C02	Speaker Pad
20	3980546B02	Front-Shield Ground Contact
21	7580685K01	Pad
22	7580428K02	Keypad
23*	---	Heat-Sealed Flexible Cable
24*	---	LCD, 7 segments, 8 characters, 8 annunciators

REF. NO.	PART NO.	DESCRIPTION
25	---	Logic Board, Assembled (see manual depending on frequency)
26	6180687K01	Light Pipe
27	2680402K01	Logic Board Shield
28	4105944K01	Battery Latch Spring, 2 used
29	5580438B01	Latch
30	4380190R04	Shield Clip, 2 used
31	2680532C01	Front Shield
32	8408051Y01	RF-to-Logic Flexible Circuit
33	FUF5690A	RF Board, Assembled
34	3286063C01	"O" Ring gasket
35	1480610B01	Chassis Insulator
36	2780549B01	Chassis
37*	---	FCC Label
38	3286074C01	Pad PTT
39	3980188R01	Contact, B+/B-
40	FLN8517A	Battery Filter Board
41	HNN9628B	Battery
42	HLN9724A	Standard Belt Clip
	or	
	HLN8255B	Spring Action Belt Clip

*Not field repairable

LTS2000 Series

Portable Accessories

Chargers

Single Unit Intellichargers, Rapid Rate

The single unit Intellicharger utilizes an enhanced charging algorithm that will help maximize the life of your batteries. It will rapid rate charge both NiCd and NiMH batteries in approximately one hour.

HTN9042A Single Unit, intellicharge rapid charger, 110V

HTN9043A Single Unit, intellicharge rapid charger, 220V, Euro plug

HTN9044A Single Unit, intellicharge rapid charger, 240V, UK plug



HTN9042A

Single Chargers, Standard Rate

The single unit standard charger charges NiCd batteries only in approximately 16 hours.

HTN9702A Single Unit, standard charger, 110V



HTN9702A

HTN9804A Single Unit, standard charger, 220V, Euro plug

HTN9805A Single Unit, standard charger, 240V, UK plug

Chargers

Multi-Unit Chargers

Multi-unit chargers can charge up to six batteries in approximately one hour and are available in a variety of voltages

HTN9748C 120V, 6 Unit, 1 Hour Rapid Rate Charger (for NiCd batteries)

HTN9811C 220V, 6 Unit, 1 Hour Rapid Rate Charger (for NiCd batteries)

HTN9812C 240V, 6 Unit, 1 Hour Rapid Rate Charger (for NiCd batteries)

HTN9060A 120V, 6 Unit, 90 Minute Rapid Rate Charger (for NiCd and NiMH batteries)

HTN9061A 220V, 6 Unit, 90 Minute Rapid Rate Charger (for NiCd and NiMH batteries)

HLN9944A Wall Mounting Bracket for multiple unit



HLN9944A

Travel Charger

A great traveling companion that ensures constant communication while on the road. Allows the battery to rapid charge while using the radio. Users can receive communication immediately once the charger is connected, and transmit from a previously "dead" battery in just 5 minutes. This light and compact unit includes a voltage regulated lighter adapter, custom charger base, mounting bracket and coil cord. Ideal for public safety, utility and construction markets.

RLN4833A Travel Charger



RLN4833A

LTS2000 Series

Portable Accessories

Chargers

Travel Charger Mounting Bracket

0780384K84 Universal Mounting Bracket for Travel Charger. Includes screws and nylon cord.

Travel Charger AC Transformer

Travel charger AC transformer adapts onto the cigarette lighter adapter cord to allow it to be plugged into an AC wall outlet for indoor use.

2580600E05 Transformer 120V (US)

2580600E06 Transformer 230V (Euro)

2580600E07 Transformer 230V (U.K.)

2580600E08 Transformer 220V (Argentina)

Vehicular Charger

The vehicular charger is designed to easily charge your batteries in a vehicle by adapting a single unit, rapid rate charger to the cigarette lighter receptacle. This is ideal when a radio is often used in a vehicle.



HLN9719A

HLN9719A Vehicular Charger Adapter/Bracket, 12 Volts for use with Rapid Rate Chargers HTN9630, HTN9802, HTN9803, HTN9167, HTN9168, or HTN9169

Motorola Conditioning Charger (MCC)

The MCC utilize negative pulse charging technology that will help extend battery life and enhance battery operation. It will safely condition and charge your specified NiCd and NiMH batteries in approximately an hour. The MCC controls heat buildup due to its charging and termination algorithms and maintenance mode allows batteries to be safely left on the charger for extended periods of time. And now there is an Instant Fault Detection (IFD) feature which detects faulty radio batteries in seconds, which notifies the user that the battery will not operate at peak performance. Optional accessories are available allowing these chargers to be used in both AC and DC environments providing optimal charging flexibility.

WPPN4002BR Base Charge Unit with Adapter Plate, 110VAC (order adapter plates separately)



WPPN4002BR

WPPN4006CR Base Charge Unit with Adapter Plate, 220V AC (order adapter plates separately)

WPPN4005CR Adapter only, 7V

WPLN4088CR MCC Kit, 110V AC (includes base unit and 7V adapter)

WPLN4089CR MCC Kit, 220V AC (includes base unit and 7V adapter)

WPPN4065BR Multi-Unit, four station base, 110V (order adapter plates separately)

3080384G15 Cigarette Lighter Adapter Cord

RLN4814A Vehicular Mounting Bracket for single unit Motorola Conditioning Charger



RLN4814A

LTS2000 Series

Portable Accessories

Battery Maintenance System^{plus} (BMS^{plus})

Increase the useful life of our batteries using interchangeable battery adapters (sold separately). The BMS^{plus} is capable of charging and discharging, analyzing, conditioning and cycle testing on NiCd, NiMH, Li-ion batteries; tracking battery voltage and capacity (mAh). The BMS^{plus} offers a 3-year warranty. Its easy-to-use design supports hundreds of 2-way, cellular, and camcorder batteries with printer port* (Serial-RS-232C port – uses female 9-pin to male 25-pin cable).

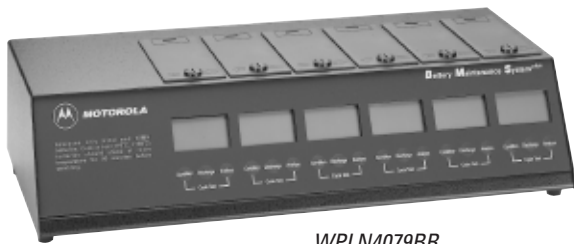

WPLN4079BR

WPLN4079BR Six-Station, 110V AC, 50/60 Hz

WPLN4080BR Six-Station, 230V AC, 50/60 Hz

WPPN4085AR BMS^{plus} field Upgrade Kit or WPLN4079AR, WPLN4080AR, and WPLN4081AR; allows these units to support Li-ion battery chemistries

NDN4005B Three-Station, 110V AC 50/60 Hz (does not support Li-ion or 3-cell batteries)

NDN4006B Three-Station, 230V AC 50/60 Hz (does not support Li-ion or 3-cell batteries)

BMS^{plus} Adapter

TDN9437A Adapter, for use with HNN9628A and HNN9701A batteries

TDN9438A Adapter, for use with HNN8308A and HNN9808A batteries

TDN9662A Adapter, for use with HNN9628A

Battery Optimizing System II (BOS II)



WPLN4124AR

No other battery analyzer matches the speed, accuracy, and versatility of the Battery Optimizing System II. Ideal for large fleet, public safety, and all other users who rely on their battery performance. Now with increased power, more sophisticated programming options, and easier to use navigation paths, optimizing your batteries was never easier. Key features include:

- Support for NiCd, NiMH, Li-ion, and SLA batteries
- 100 watt power supply and programmable from 100 mAh to 4 amps per station
- Interchangeable adapters accommodate all major brands
- Includes a variety of user programs and allows for customizable programming
- Proprietary recondition cycle restores NiCd and NiMH batteries
- Increased processing power and testing resolution – including a three minute Quicktest that measures the batteries State of Health (SoH)
- Printer output for reports and labels
- Three year warranty

WPLN4124AR BOS II, Four-Station, 100-240V AC (US line cord)

WPLN4125AR BOS II, Four-Station, 100-240V AC (UK/Euro line cords)

BOS II Adapter

RL-71883 Standard Adapter, LTS2000

* Compatible with the STAR Micronics SP200 series printers, available from any STAR Micronics distributor, and other printers with STAR emulation.

LTS2000 Series

Portable Accessories

Vehicular Holders

The portable radio hanger slides over and hangs from the door panel in a vehicle. The radio's belt clip slides onto the portable hanger allowing convenient, easy mounting. Two sizes are available to fit door panels.

TDN9327A Portable Radio Hanger for door panels up to 2-3/4"

TDN9373A Portable Radio Hanger for door panels to, 2-3/4" to 3-1/4"



Carrying Accessories

High Activity Swivel Carry Cases

The following carry cases have a high activity swivel "D" button and belt loop. To remove case from belt loop, rotate case 180 degrees and slide case upward, out of the holder. Case stays on belt more securely in high activity applications.

HLN9421A DTMF Leather Carry Case with High Activity Swivel Belt Loop for use with standard battery

HLN9426A DTMF Leather Carry Case with High Activity Swivel Belt Loop for use with FM Approved 1100 mAh Battery

HLN9427A DTMF Leather Carry Case with High Activity Swivel Belt Loop for use with FM approved 600 mAh battery



HLN9421A

Carry Holder

HLN9076B Molded Carry Holder (high capacity battery)

HLN8044A Strap for molded carry holder, snap

Carrying Accessories

Carrying Cases

Carrying cases provide a convenient way to carry your radio while protecting it from the environment. The carrying cases are available in sizes designed to fit your radio & battery and permit audio to be heard clearly.



HLN9428A

Standard Belt Loop Carry Cases

HLN9428A DTMF Leather Carry Case with Belt Loop for use with Standard Battery

HLN9429A DTMF Leather Carry Case with Belt Loop for use with FM Approved 1100 mAh Battery

HLN9431A DTMF Leather Carry Case with Belt Loop for use with FM Approved 600 mAh Slim Battery

LTS2000 Series

Portable Accessories

Carrying Accessories

Belt Loops



NTN8039B

NTN8039B 2-1/2" Replacement Swivel Belt Loop for high activity swivel cases



NTN8040B

NTN8040B 3" Replacement Swivel Belt Loop for high activity swivel Cases

Belt Clips

HLN9724A Belt Clip, 2-1/2"

HLN8255B Spring Action Belt Clip, 3"

Belt

4200865599 1-3/4" wide leather belt

T-Strap

HLN9975A Strap for DTMF carry case, snap

HLN9975B



NTN5243A

Carrying Strap

NTN5243A Carry Strap, black nylon, adjustable length, attaches to "D" rings on carrying cases

Swiveller

TDN1002A Swiveller (includes holster, belt and strap)

Carrying Accessories

Waterproof Bag

HLN9985B Waterproof Bag, includes large carrying strap

Chestpack

HLN6602A Universal Chest Pack with Radio Holder, Pen Holder and Velcro Secured Pocket

1505596Z02 Replacement Strap for HLN6602A



HLN6602A

Break-A-Way Chest Pack

All of the same features as the original chest pack (HLN6602A) plus break-a-way tabs that allow the entire pack to be pulled off with approximately 10 lbs. of pressure. Perfect for railroads, manufacturing locations, construction sites and anywhere safety is a concern.

RLN4570A Break-A-Way Chest Pack



RLN4570

RadioPAK™

RLN4815A Universal RadioPAK™ with Radio Holder. Worn around waist with adjustable belt. Includes attached 6" by 8" zippered pouch for other job necessities.

4280384F89 Universal RadioPAK™ belt lengthener; fits waists larger than 40"



RLN4815A

LTS2000 Series

Portable Accessories

Audio Accessories

Remote Speaker Microphone (RSM)

Allows you to talk and listen without removing the radio from the belt, case or charger. Ideal for high noise level environments. This water resistant microphone includes: 6.0" coiled cord assembly, and swivel clip

HMN9030A Remote Speaker Microphone



HMN9030A

RSM Accessories

Epaulet Strap

Black leather epaulet strap secures remote speaker to epaulet straps on shirt or jacket and accommodates back clip in leather cut-outs. Snap closure secures remote speaker microphone cord to allow reliable communications in hostile environments.

RLN4295A Epaulet Strap, Small Clip



RLN4295A

Audio Accessories

Surveillance Kits

Surveillance accessories allow the user to privately receive communications with the earpiece and are ideal when environments require discreet communications.

HMN9727B Receive-only Surveillance Kit, beige (1-Wire)

RLN4894A Receive-only Surveillance Kit, black (1-Wire)

HMN9752B Receive-only Surveillance Kit with Volume Control, beige (1-Wire)

HMN9754D Surveillance Kit with Microphone and Push-To-Talk Combined, beige (2-Wire)

RLN4895A Surveillance Kit with Microphone and Push-To-Talk Combined, black (2-Wire)

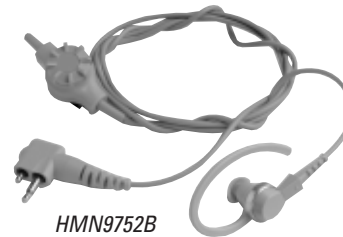

HMN9752B

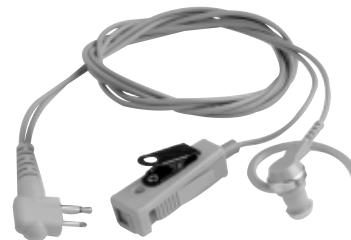

HMN9754D

Surveillance Replacement Items

5080371E73 Standard Rubber Eartips, pack of 25, beige

5080371E75 Standard Rubber Eartips, pack of 25, black

5080369E40 Earloop, plastic, beige

5080370E92 Earloop, plastic, black

5880377E06 Plastic Earloop Adapter

5080369E38 Standard Earpiece Assembly (includes Earphone, Earloop, and Eartip), beige

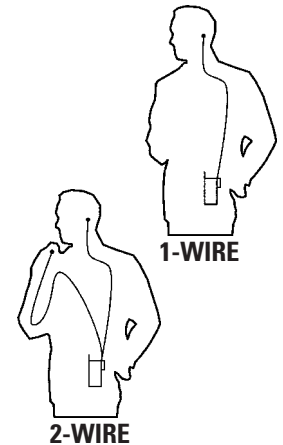

LTS2000 Series

Portable Accessories

Audio Accessories

Noise Kits

This lightweight translucent tube attaches to Motorola surveillance accessories to provide additional flexibility and comfort. Clothing clip prevents the accessory from being pulled from the ear due to body movement or head rotation.

NTN8370A Extreme Noise Kit, includes 2 foam earplugs for loud environments, provides 24dB of noise reduction

NTN8371A Low Noise Kit, includes rubber eartip for low noise environments, does not provide hearing reduction



NTN8370A

5080384F72
Replacement Foam Plugs; pack of 50 (for use with NTN8370A)



NTN8371A

5080371E73 Beige Replacement Standard Rubber Eartips; for use with NTN8371A (Pack of 25)

5080371E75 Black Replacement Standard Rubber Eartips; for use with NTN8371A (Pack of 25)

Audio Accessories

Clear Comfortable Earpiece

The clear comfortable earpiece forms to the inside of your ear and is perfect for low noise environments. Compatible with the NTN8371, clear acoustic tube assembly and most surveillance kits (1-, 2-, and 3-wire). This earpiece is made of easy-to-clean chemically inert, hypoallergenic material. There are three items need to make this product work:

- 1) Clear Comfortable Earpiece,
- 2) Clear Acoustic Tube Assembly (NTN8371), and
- 3) Surveillance Kits.

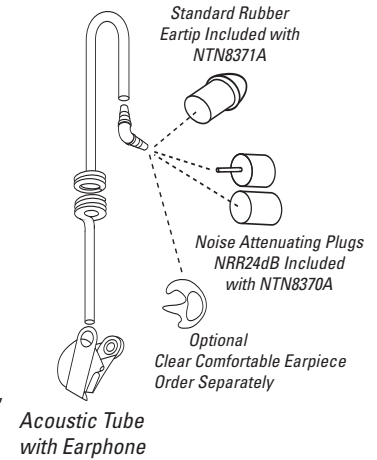

RLN4760A Small Custom Earpiece, right ear

RLN4763A Small Custom Earpiece, left ear

RLN4761A Medium Custom Earpiece, right ear

RLN4764A Medium Custom Earpiece, left ear

RLN4762A Large Custom Earpiece, right ear

RLN4765A Large Custom Earpiece, left ear

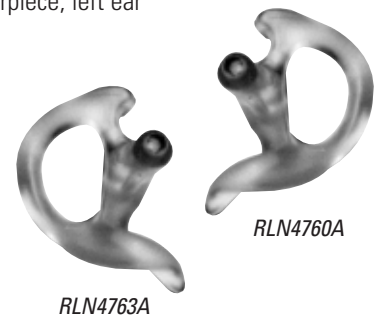

LTS2000 Series

Portable Accessories

Audio Accessories

Ear Microphone System (EMS)

This compact unit picks up the voice through bone vibrations in the ear canal. The miniature earpiece leaves the hands free and face unobscured when worn by rescue and hazard protection personnel, who still retain the ability for direct hearing and speaking. For personnel required to wear breathing apparatus, communications with protective masks are as clear as communications without. And its high speech clarity under noisy environments makes it ideal for high noise environments. Available in PTT or Voice Activated (VOX).

Interface Module needs to be ordered separately for EMS to work.

BDN6677A Ear Microphone for Standard Noise Levels (up to 95dB, black)

BDN6678A Ear Microphone for Standard Noise Levels (up to 95dB, beige)

BDN6641A Ear Microphone for High Noise Levels (up to 105dB)



BDN6641A
Requires
interface module
sold separately



BDN6708B

Interface Module For EMS

BDN6708B Push-To-Talk Interface Module

BDN6671B Push-To-Talk or Voice-Activated Interface Module

Audio Accessories

Optional Accessories For EMS

0180358B38 Remote Push-To-Talk Ring Switch



0180358B38

0180300E25 Earguard with adjustable loop, secures ear mic in ear



0180358B33

0180358B32 Small size black earholder secures microphone in ear

0180358B33 Medium size black earholder secures microphone in ear

0180358B34 Large size black earholder secures microphone in ear

0180358B35 Small size clear earholder secures microphone in ear

0180358B36 Medium size clear earholder secures microphone in ear

0180358B37 Large size clear earholder secures microphone in ear

4280369E44 Replaceable belt clip with screws

5080358B28 Medium size black eartips (10 per pack)

5080358B29 Large size black eartips (10 per pack)

5080358B30 Medium size beige eartips (10 per pack)

5080358B31 Large size beige eartips (10 per pack)

Flexible Ear Receivers

This receiver-only earpiece contains a flexible earloop and speaker which rests external to the ear.

BDN6720A Flexible Ear Receiver

7580372E11 Replacement Foam Ear Cushion for BDN6720

Lightweight Headsets

Lightweight headsets allow for high clarity, hands free, discreet two-way communications while adding comfort necessary for extended wear in moderate noise environments.

***RMN4016A** Lightweight Single Speaker Headset with Swivel Boom Microphone for left or right ear operation and In-line PTT button

REX4648A Replacement Foam Earpad and Windscreen for RMN4016A



RMN4016A

* Intrinsically safe

LTS2000 Series



Accessories, Antennas, Batteries

Audio Accessories

Completely Discreet Earpiece

Remain discreetly in touch with the miniaturized Phonak Phonito receiver. All messages received through the user's two-way radio are inductively relayed to the wireless Phonito in the user's ear. Inductive neckloop is easily hidden under the user's clothing for covert operations. Neckloop attaches to the user's Motorola Surveillance Kit providing completely discreet two-way communications. Security operatives, public safety officials, and private investigators can communicate with ease without any visible equipment. Small as it is, it offers a full range of audio functions including automatic squelch, automatic gain control and noise filtering. Must be used in conjunction with a Motorola Surveillance Kit. Just remove the earpiece on any standard 2- or 3-wire surveillance kit and plug in the neckloop for completely discreet communication.



RLN4922A

RLN4922A Completely Discreet Earpiece Kit; includes wireless earpiece, inductive neckloop, 6 spare batteries and 5 spare ear wax guard

RLN4919A Replacement Ear Wax Guards, 5 per pack

RNN4005A Replacement 1.4V Battery, 6 per pack

Portable Antennas

Flexible Whip Antenna

Flexible Whip antennas have a one-piece finish and steel core for optimal radiation characteristics. Provides more comfort when radio is worn on the belt.

8505241U03 Flexible Whip, 806-870MHz, 7"

Stubby Antenna

This stubby quarterwave antenna is ideal when radio is worn on the belt because the short antenna is non-obtrusive.

***8505241U06** Stubby, 806-941MHz, 4"



8505241U06

** 8505241U06 is a broad band antenna that operates in the 800/900MHz band*

Portable Batteries

Nickel-Cadmium Premium

Part Number: **HNN8133C**

Volts: 7.5

Avg. mAh: 1200

Height: 5-1/2"

Intrinsically Safe: Yes

Part Number: **HNN8308A**

Volts: 7.5

Avg. mAh: 600

Height: 5-1/2"

Intrinsically Safe: No

Slim: Yes

Part Number: **HNN9628B**

Volts: 7.5

Avg. mAh: 1200

Height: 5-1/2"

Intrinsically Safe: No

Part Number: **HNN9701A**

Volts: 7.5

Avg. mAh: 1100

Height: 5-1/2"

Intrinsically Safe: Yes

Part Number: **HNN9808B**

Volts: 7.5

Avg. mAh: 600

Height: 5-1/2"

Intrinsically Safe: Yes

Slim: Yes



HNN9628B

Powerline

Part Number: **WPNN4044AR**

Volts: 7.5

Avg. mAh: 1000

Height: 5-1/2"

Intrinsically Safe: No

LTS2000 Series

Service Aids, Manuals

Service Aids

Radio Interface Box

Links radio programming cable and computer interface together. Provides required voltage shift to enable communications between radio and computer.

RLN4008E Radio Interface Box



RLN4008E

Programming Cable

Connects radio interface box to radio for programming.

HKN9857A Programming/Test Cable



0180357A57

Wall Mounted Power Supply

Used to supply power to radio interface box, RLN4008E

0180357A57 Wall Mounted Power Supply, 110 Volts

0180358A56 Wall Mounted Power Supply, 220 Volts

Service Aids

Computer Interface Cable

Used to connect computer's serial port to Radio Interface Box.

3080369B71 Cable, RIB to 25 pin D

3080369B72 Cable, RIB to 9 pin D



3080369B71

Programming Software

Utilizing your personal computer, this software enables you to add/or reprogram frequencies as your requirements change. Radio Interface Box and proper cables, order separately.

RVN4156N Programming Software, 3-1/2" diskette (includes manual and storage box)

Manuals

- 6802945C85** User Manual
- 6802945C75** Service Manual
- 0180305J46** Ear Microphone System and Temple Transducer CD-ROM

Over 7 million customers have made MyRadioMall.com America's #1 choice when it comes to dependable and reliable Motorola Communications at fantastic prices.

We are now celebrating our 12th year of online service and the best is yet to come.



Advanced Radio Systems, Inc
8726 NW 26 Street #6
Miami, Florida 33172
Voice Numbers: 305-884-1795
Toll Free: 1-866-900-Mall (6255)
Fax Number: 305-884-1985

12/25/2006