

HT1000 Series

Parts List

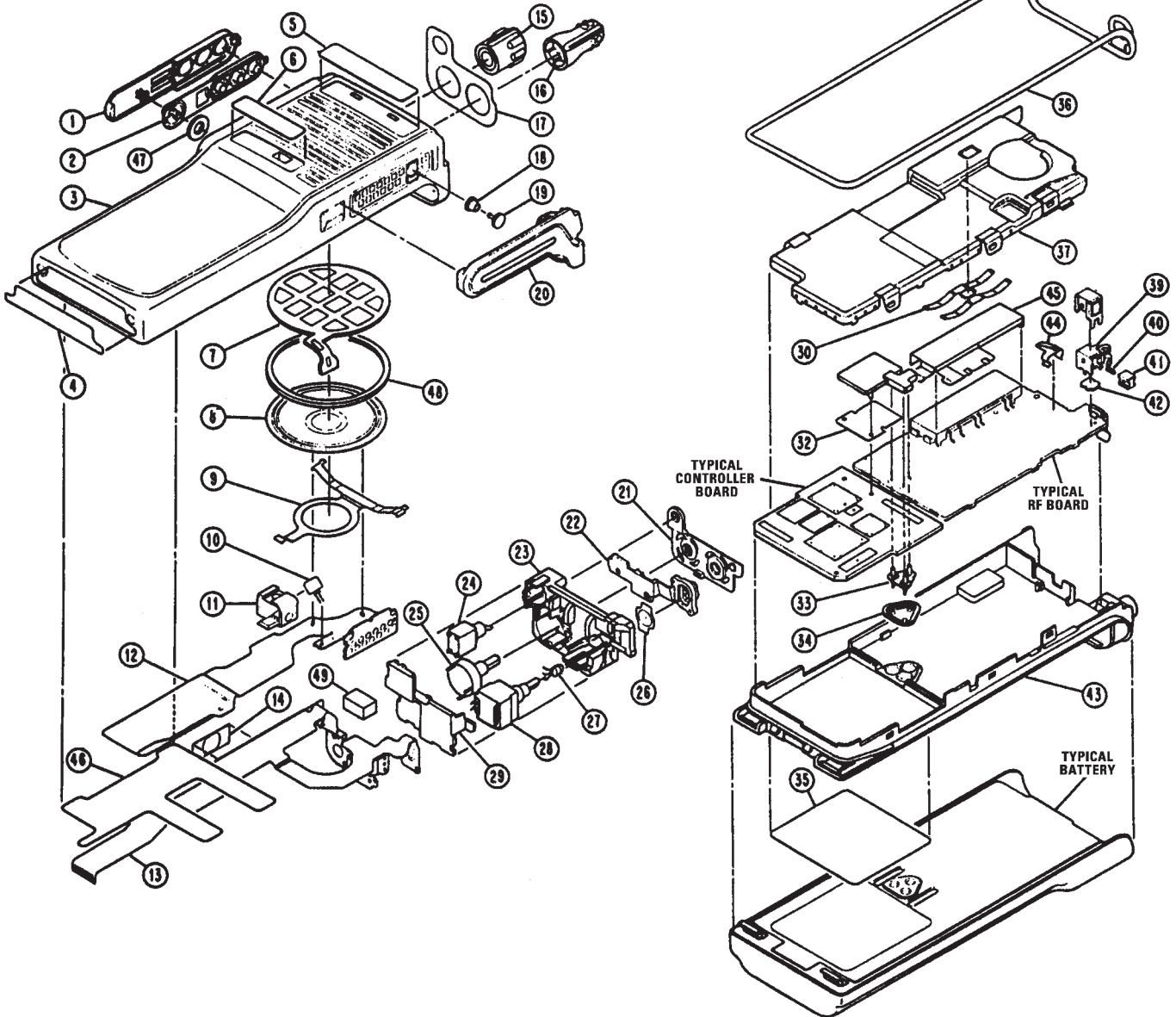

HT1000 Series

Parts List

REF. NO.	PART NO.	DESCRIPTION
1	4505896U02	Lever, PTT
2	3205902U01	Seal, PTT, and Actuator for S404, S405, S406 S408
3	1505627V05	Cover, Front
4	----	Label, Agency Approval; not field replaceable
5	3305183R55	Label, Motorola
6	3305183R56	Label, HT1000
7	3505535X02	Felt, Speaker
8	See Note 1	Speaker (LS401) – not available
9	0705470V01	Bracket, Speaker Retainer
10	See Note 1	Microphone (MK401) – not available
11	1405330W02	Boot, Microphone
12	8405310W04	FLEX, Front Cover/Display
13	8405333W03	FLEX, Controls
14	3905517V01	Popple, PTT (p/o S406)
15	3605253V01	Knob, On/Off/Volume
16	3605254V02	2-Frequency Radios
	or	
	3605254V03	8-Frequency Radios
	or	
	3605254V01	16-Frequency Radios
17	1305872U02	Escutcheon, Control Top
	or	
	1305872U03	2-Frequency Radios
	or	
	1305872U01	8-Frequency Radios
	or	
	1305872U01	16-Frequency Radios
18	3205160W01	Seal, Actuator; for S101
19	2205159W01	Pin, Actuator; for S101
20	3205514W01	Seal, Accessory Connector
21	3205177Z01	Seal, Control Top
22	3205178Z01	Seal, Emergency Button
23	2705877U01	Housing, Switch
24	See Note 1	Switch, Toggle (S402) – not available

REF. NO.	PART NO.	DESCRIPTION
25	See Note 1	Potentiometer/Switch On/Off/Volume Control (R401/S403) – not available
26	3905329W01	Popple, Emergency Button
27	See Note 1	LED (CR702A/CR702B) – not available
28	See Note 1	Switch, Frequency (S401) – not available
29	1505632V01	Cover, Switch Housing
30	----	Spring, PA; not field replaceable, order front shield (item 37) – not available
32	8405247V01	FLEX, Jumper
33	See Note 2	Plug, Connector (P404) – not available
34	3205820V01	Seal, Connector Plug
35	----	Label, Rear; Information; not field replaceable
36	3205176Z01	“O” Ring, Contoured/Seal, Antenna
37	2605891U03	Shield, Front
38	4005831W01	Bracket, RF Switch
39	----	Housing, RF Switch
40	4105266V01	Spring, RF Switch
41	4405524V01	Piston, RF Switch
42	----	Circuit Board, RF Switch
43	1505892U06	Chassis (Rear Cover)
44	3905838V01	Contact, Antenna Shield Ground (800 MHz and 900 MHz radios only)
45	2605898U01	Shield, PA (800 MHz and 900 MHz radios only)
46	7505334W01	Pad, Sound Dampening
47	0405717W01	Washer, PTT Seal
49	7505393N33	Pad, Shock

NOTES:

1. Refer to electrical parts list (miscellaneous) for part number and complete description.
2. Refer to electrical parts list (transceiver board) for part number and complete description.

HT1000 Series



Portable Accessories

Chargers

Single unit chargers are available in either desktop or compact styles for small system users. Multiple unit chargers can be wall or rack mounted and are ideal for multi-shift operations. All chargers are specifically designed to meet the requirements of batteries manufactured by Motorola. All chargers listed are rapid rate and will fully charge your battery in less than 3 hours.

Single Unit Compact Bi-Chemistry Chargers – Rapid Rate

The bi-chem charger has the power supply built into the line cord giving the user a smaller base unit for easier storage. It also utilizes an enhanced charging algorithm that will help maximize the life of your batteries. It will rapid rate charge both NiCd and NiMH batteries.

RPX4747A Compact Bi-Chem Charger, 110V

RPX4748A Compact Bi-Chem Charger, 230V Euro plug

RPX4749A Compact Bi-Chem Charger, 230V UK plug

Chargers

Multiple Unit Charger (MUC)

Multi-unit chargers offer six pockets that can be used to rapid charge 1 to 6 batteries simultaneously. The batteries can be charged with the radios or separately. They will rapid rate charge both NiCd and NiMH batteries.

NTN1177D Six-Pocket, rapid rate 110V

NTN1178D Six-Pocket, rapid rate, 220V (supplied with 2 prong cord)

NTN1179D Six-Pocket, rapid rate, 240V (supplied with 3 flat prong cord)



NTN1177D

MUC Accessories

NLN7967A Wall Mount

Travel Charger

RLN4884B Travel Charger kit includes a cigarette lighter adapter attached to a rapid charger and mounting bracket. Allows radio to be used while it is charging.



RLN4884B

Travel Charger Mounting Bracket

0780384K84 Universal Mounting Bracket for Travel Charger. Includes screws and nylon cord.

Travel Charger AC Transformer

Travel charger AC transformer adapts onto the cigarette lighter adapter cord to allow it to be plugged into an AC wall outlet for indoor use

2580600E05 Transformer 120V (US)

2580600E06 Transformer 230V (Euro)

2580600E07 Transformer 230V (U.K.)

2580600E08 Transformer 220V (Argentina)

HT1000 Series

Portable Accessories

Motorola Conditioning Charger (MCC)

The MCC will help extend battery life and enhance battery operation. It will safely condition and charge your specified nickel cadmium (NiCd) and nickel metal hydride (NiMH) batteries in approximately an hour.

WPLN4090BR MCC Kit, 110V AC; includes both base unit and 7V adapter

WPLN4091BR MCC Kit, 220V AC; includes both base unit and 7V adapter

WPPN4002BR 110V AC Base Charge Unit Only (order adapter plate separately)

WPPN4006AR 220V AC Base Charge Unit Only (order adapter plate separately)

WPPN4065BR Multi-Unit Conditioning Charger Four Station Base 110V (order adapter plate separately)

WPPN4004BR 7 Volt Adapter Only

3080384G15 Cigarette Lighter Adapter Cord; MCC multi-unit conditioning charger

RLN4814A Vehicular Mounting Bracket for single unit Motorola Conditioning Charger

3080384M21 DC Hard wire cable for vehicular installation (included in RLN4814A)



WPPN4002BR

Battery Maintenance System^{plus} (BMS^{plus})

Increase the useful life of your batteries.

Using interchangeable battery adapters (sold separately), the BMS^{plus} is capable of charging and discharging, analyzing, conditioning and cycle test on batteries; tracking battery voltage and capacity (mAh).

The BMS^{plus} offers a 3 year warranty. Its easy-to-use design supports hundreds of 2-way, cellular, and camcorder batteries with printer port* (Serial-RS-232C port – uses female 9-pin to male 25-pin cable).

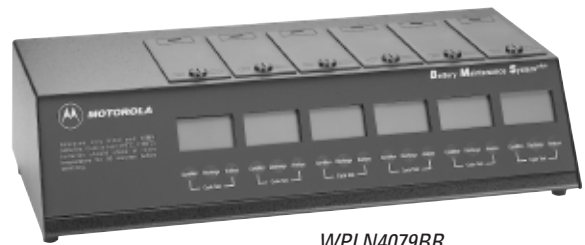

WPLN4079BR

WPLN4079BR Six-Station, 110V AC, 50/60 Hz

WPLN4080BR Six-Station, 230V AC, 50/60 Hz

WPPN4085AR BMS^{plus} field upgrade kit for WPLN4079AR, WPLN4080AR and WPLN4081AR allows these units to support Li Ion battery chemistries

NDN4005B Three-station 110V AC, 50/60 Hz

NDN4006B Three-station 230V AC, 50/60 Hz

BMS^{plus} Adapter

TDN9435C Adapter Compatible with NiCd Batteries Only

CDN6364A Adapter Compatible with Both NiCd and NiMH Batteries

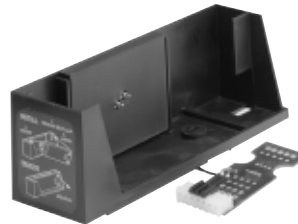

TDN9435C

*Compatible with the STAR Micronics SP200 series printers, available from any STAR Micronics distributor, and other printers with STAR emulation.

HT1000 Series

Portable Accessories

Battery Optimizing System II (BOS II)



WPLN4124AR

No other battery analyzer matches the speed, accuracy, and versatility of the Battery Optimizing System II. Ideal for large fleet, public safety, and all other users who rely on their battery performance. Now with increased power, more sophisticated programming options, and easier to use navigation paths, optimizing your batteries was never easier. Key features include:

- Support for NiCd, NiMH, Li-ion, and SLA batteries
- 100 watt power supply and programmable from 100 mA to 4 amps per station
- Interchangeable adapters accommodate all major brands
- Includes a variety of user programs and allows for customizable programming
- Proprietary recondition cycle restores NiCd and NiMH batteries
- Increased processing power and testing resolution – including a three minute Quicktest that measures the batteries State of Health (SoH)
- Printer output for reports and labels
- Three year warranty

WPLN4124AR BOS II, Four-Station, 100-240V AC (US line cord)

WPLN4125AR BOS II, Four-Station, 100-240V AC (UK/Euro line cords)

BOS II Adapter

RL-72403 Standard Adapter

impres™ Smart Energy System



WPLN4111AR

The impres smart energy system ensures maximum talk-time and optimized battery cycle life through the use of its advanced charging algorithm and automatic reconditioning features. The smart energy system reconditions impres batteries when they need it, automatically, keeping them in peak condition. It's advanced conditioning features allow batteries to be safely left on

the charger for extended periods of time without incurring the damaging heat build-up which can rob batteries of cycle life. In addition, batteries left on the charger are kept fully charged so they are always ready when you need them. The impres system reconditions batteries when they need it based on their usage pattern. Talk time and cycle life are optimized and the need for manual maintenance programs reduced or eliminated. This rapid-rate tri-chemistry charging system will also charge existing legacy batteries and supports multiple radio platforms including Saber, XTS, and HT1000 series portables.

WPLN4111AR impres Single Unit Charger

WPLN4108BR impres Multi-Unit Charger

impres™ Multi-Unit Charger with Display Modules

The impres Multi-Unit Charger with Charger Display Modules has a two-line LCD screen for each of its six charger pockets that provides users with a host of valuable battery information. When a calibrated impres battery is inserted into a pocket, it provides the current battery mAh and percent of rated capacity which allows the user to immediately know the status of the battery without having to charge and discharge the battery. Additionally, the unit displays the remaining charge time (NiCd and NiMH only) which lets the user know when the impres battery will be ready for use. Additional information displayed includes: battery serial and part number information, battery chemistry, voltage and charge status and the version of the charger and display modules.

WPLN4130AR Multi-Unit Charger with Display Modules

RLN5382A Charger Display Module for impres multi-unit charger version 1.3 or later

RLN5591A Charger Display Module for impres multi-unit charger version 1.2 or earlier (Requires unit to be sent to the Rockford Service Center – instruction sheet provided)



WPLN4130AR

HT1000 Series

Portable Accessories

impres™ Smart Energy System

impres™ Bundle Packs

Provide significant savings on the impres products by bundling a charger and batteries together as a smart energy system package.

RLN5265A impres™ single unit charger with two HNN9029AR batteries

RLN5266A impres™ single unit charger with two HNN9028AR batteries

RLN5439B impres™ multi unit charger with six HNN9029AR batteries

RLN5440B impres™ multi unit charger with six HNN9028AR batteries

Vehicular Charger

This 12V DC charger is ideal for mobile customers; it charges portable radio NiCd batteries in rapid charge mode (in less than 3 hours) until full charge is obtained and then switches to trickle charge mode. A microprocessor controls the charge rate. This durable unit comes with a metal mounting bracket and is PAC-RT compatible.

TDN9816A Vehicular Charger



TDN9816A

Carrying Accessories

Carrying Cases

A variety of carrying accessories are available for your comfort and convenience. The carrying cases are available in sizes designed to fit your radio & battery and permit audio to be heard clearly.

Standard Belt Loop Carrying Cases



NTN7247A

NTN7238A Leather Carry Case with Belt Loop and T-Strap for use with high capacity battery

NTN7239A Leather Carry Case with Belt Loop and T-Strap for use with ultra-high capacity battery

NDN4018B DTMF Leather Carry Case with Belt Loop for use with high and ultra-high capacity batteries

NTN7247A Nylon Carry Case with Belt Loop and Strap for use with high and ultra-high capacity batteries

High Activity Swivel Carrying Cases

The following carrying cases have a high activity swivel "D" button and belt loop. To remove case from belt loop, rotate case 180 degrees and slide case upward, out of the holder. Case stays on belt more securely in high activity applications versus standard swivel cases while allowing the radio to swing freely with body movements.

NTN8035B Leather Carry Case with 2.5" High Activity Swivel Belt Loop and T-Strap for use with high capacity battery

NTN8037B Leather Carry Case with 3.0" High Activity Swivel Belt Loop and T-Strap for use with high capacity battery

NTN8036B Leather Carry Case with 2.5" High Activity Swivel Belt Loop and T-Strap for use with ultra-high capacity battery



NTN8036A

HT1000 Series

Portable Accessories

Carrying Accessories



NTN8038A

NTN8038B Leather Carry Case with 3.0" High Activity Swivel Belt Loop and T-Strap for use with ultra-high capacity battery

NDN4017B DTMF Leather Carry Case with 3.0" High Activity Swivel Belt Loop and Antenna Strap for use with high and ultra-high capacity battery

T-Strap

NTN7782A T-Strap for leather Carry Cases

NTN7376A T-Strap for nylon carry cases

Belt Loops

NTN8039B 2.5" High Activity Swivel Belt Loop

NTN8040B 3.0" High Activity Swivel Belt Loop

NTN1534A High-activity "D" button and 2.5" belt loop

NTN1535A High-activity "D" button and 3.0" belt loop

Belt Clips

4205638V07 3" Belt clip

4205638V09 2.5" Belt clip



4200865599

Belt

4200865599 1.75" Wide Black Belt



NTN5243A

Carrying Strap

NTN5243A Shoulder Carry Strap, allows easy carrying of radio in a case when not wearing a belt

Carrying Accessories

Waterproof Bag

HLN9985B Waterproof bag includes large carrying strap

Swiveller

TDN9684A Swiveller, includes clip button, holster and belt



TDN9684A

Swiveller Replacement Accessories

TDN9690A Clip button, mounts on battery

TDN9688A Holster, compatible with all buttons

TDN9687A Belt, 2" nylon



TDN9687A

Portable Radio Hanger

The portable radio hanger slides over and hangs from the door panel in a vehicle. The radio's belt clip slides onto the portable hanger allowing convenient, easy mounting. Two sizes are available to fit door panels.



TDN9327A

TDN9327A Portable Radio Hanger for door panels up to 2.75"

TDN9373A Portable Radio Hanger for door panels up to 3.25"

Universal Holders

RLN4943A Universal holder with gooseneck bracket

RLN4944A Wheelchair quick release assembly

RLN4945A Universal holder with gooseneck bracket and wheelchair quick release assembly

HT1000 Series

Portable Accessories

Carrying Accessories

Chest Pack

Carry the radio mounted on chest with adjustable straps over shoulders and around waist.

HLN6602A Universal Chest Pack with Radio Holder, Pen Holder, and Velcro Secured Pouch

1505596Z02 Replacement Strap for HLN6602A



HLN6602A

Break-A-Way Chest Pack

All of the same features as the original chest pack (HLN6602A) plus break-a-way tabs that allow the entire pack to be pulled off with approximately 10 lbs. of pressure. Perfect for railroads, manufacturing locations, construction sites and anywhere safety is a concern.

RLN4570A Break-A-Way Chest Pack



RLN4570A



RadioPAK™

RLN4815A Universal RadioPAK™ with Radio Holder. Worn around waist with adjustable belt. Includes attached 6" by 8" zippered pouch for other job necessities.

4280384F89 Universal RadioPAK™ belt lengthener; fits waists larger than 40"

Audio Accessories

Remote Speaker Microphones (RSM)

Allows you to talk and listen without removing the radio from the belt case or charger. Ideal for high noise level environments. These water resistant microphones include coil cord assembly, 3.5mm earjack, swivel clothing clip and quick disconnect latch.

***NMN6193C** Remote Speaker Microphone

***NMN6191C** Noise Cancelling Remote Speaker Microphone



NMN6193B

0104010J46 Replacement Coil Cord Cable Assembly for Remote Speaker Microphones

RLN5002A MicJacket Kit; compatible with NMN6191 and NMN6193 remote speaker microphones

Public Safety Speaker Microphones (PSM)

Public Safety Speaker Microphones include straight cord assembly, 3.5mm earjack, swivel clothing clip, quick disconnect latch, antenna connector, receiver, and audio high/low volume push button. Antenna must be ordered separately. Use radio antennas on page 162.

***NMN6228C** 30" Noise-Cancelling Public Safety Speaker/Microphone, straight cord

***NMN6243B** 18" Noise-Cancelling Public Safety Speaker/Microphone, straight cord

***NMN6244B** 24" Noise-Cancelling Public Safety Speaker/Microphone, straight cord

0104004J29 30" Public Safety Microphone Cable

0104004J46 18" Public Safety Microphone Cable

0104004J47 24" Public Safety Microphone Cable

REX4410C PTT Paddle Replacement Lit for Remote and Public Safety Microphones

RLN5004A MicJacket Kit; compatible with NMN6228, NMN6243 and NMN6244 remote speaker microphones

* Intrinsically safe

HT1000 Series

Portable Accessories

Audio Accessories

RSM Accessories

Epaulet Strap

Black leather epaulet strap secures remote speaker microphone to epaulet straps on shirt or jacket and accommodates back clip in leather cut-outs. Snap closure secures remote speaker microphone cord to allow reliable communications in hostile environments.

RLN4294A Epaulet Strap, Velcro

RLN4295A Epaulet Strap, small clip



Audio Accessories for the RSM

Plugged into the 3.5mm earjack on the RSM audio adapter, these audio accessories will mute the speaker on the RSM allowing the user to discretely hear all incoming messages. Ideal for noisy environments. The following audio accessories can also be plugged directly into the radio with the BDN6676D audio adapter.

BDN6781A Pellet Style Earpiece

BDN6719A Flexible Ear Receiver

Headsets for the RSM and PSM

RMN4056A Receive-Only Dual Muff Headband Style Headset; provides 24dB of noise reduction; for use with all Remote and Public Safety Microphones with a 3.5mm threaded jack (can be plugged directly into radio with BDN6676D adapter)

RMN4057A Receive-Only Hardhat Mount mounts easily to hardhats with slots and provides 22dB of noise reduction; for use with all Remote and Public Safety Microphones with a 3.5mm threaded jack (can be plugged directly into radio with BDN6676D adapter)



Audio Accessories

CommPort: Integrated Microphone/Receiver System

CommPort system contains a miniature microphone and receiver, and connects to your two-way radio, making it possible to hear and speak under the most adverse conditions.

***NTN1624A** Integrated Ear Microphone/Receiver System w/Palm PTT (includes BDN6676D 3.5mm Jack Adapter)

***NTN1625A** Integrated Ear Microphone/Receiver System with PTT on radio adapter (includes BDN6676D 3.5mm Jack Adapter)

***NTN1663A** Integrated Ear Microphone/Receiver System w/Ring PTT (includes BDN6676 3.5mm Jack Adapter)

***NTN1736A** CommPort integrated microphone/receiver with snap on side push-to-talk (PTT)

***NNTN4186A** Integrated Microphone/Receiver with Body Push-to-talk Button

NKN6510A Replacement Cable for NTN1624

NKN6508A Replacement Cable for NTN1625

NKN6512A Replacement Cable for NTN1663

NKN6525A Replacement cable with snap on side PTT

NNTN4188A Replacement Remote Push-to-Talk Body Switch

NTN8821A CommPort Maintenance Kit, Includes Replacement Ear Tubes (Quantity 10), Windscreens (Quantity 2) and Microphone Seal Strips (Quantity 10)

NTN8986A Adhesive Pads (Quantity 90) for secure attachment to ear

NTN8988A Ear Straps (Quantity 10), for secure attachment to ear

4285838B01 Replacement Collar Clip

4202006A01 Replacement Back Cover Clip

RLN5037A Replacement Ear tubes (Quantity 10)

* Intrinsicly safe



NTN1623A

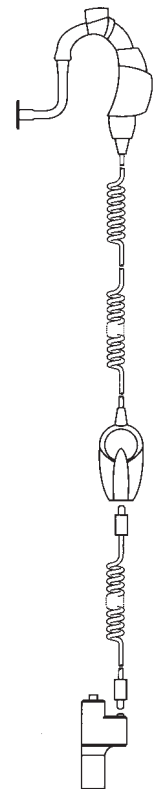

NTN1625

HT1000 Series

Portable Accessories

Audio Accessories

Surveillance Accessories

Surveillance accessories allow the user to privately receive communications with the earpiece and are ideal when environments require discrete communications.

The following surveillance accessories require the BDN6676D (3.5 mm threaded adapter jack) that attaches to the radio, unless being used with speaker/microphone.

Receive-only Surveillance Kit (1 Wire)

- *BDN6664A Beige
- *BDN6665A Beige
- BDN6726A Black
- BDN6727A Black

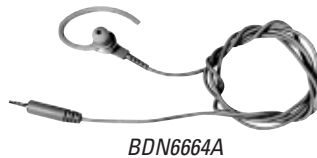

Receive-only Surveillance Kit with Volume Control (1 Wire)

- *BDN6666A Beige
- BDN6728A Black



Surveillance Kit with Microphone and Push-To-Talk Combined (2 Wire)

- *BDN6667A Beige
- *BDN6669A Beige
- BDN6729A Black
- BDN6731A Black



Surveillance Kit with Microphone and Push-To-Talk Separate (3 Wire)

- *BDN6668A Beige
- *BDN6670A Beige
- BDN6730A Black
- BDN6732A Black
- *BDN6676D 3.5mm Jack Adapter with Quick Disconnect Latch



Audio Accessories

Surveillance Kit Replacement Accessories

- 5080369E38** Standard Earpiece Assembly, includes earphone, earloop and eartip, beige
- 5080370E90** Standard Earpiece Assembly includes earphone, earloop and eartip, black
- 5080369E39** Extra Loud Assembly, includes earphone, earloop and eartip, beige
- 5080370E91** Extra Loud Earpiece Assembly, includes earphone, earloop and eartip, black
- 5080369E40** Plastic Urethane Earloop, beige
- 5080370E92** Plastic Urethane Earloop, black
- 5080371E73** Standard Rubber Eartip, beige, pack of 25
- 5080371E75** Standard Rubber Eartip, black, pack of 25
- 5880377E06** Plastic Eartip Adapter, pack of 10



Surveillance Kits with Extended Wear Earpiece

These kits include a comfort earpiece with a rubber ear tip and and a clear comfortable acoustic tube. Users can hear transmissions clearly, while the clear tube provides a discreet appearance.

- RLN5311A** Beige Two-Wire Comfort Earpiece with Combined Microphone and Push-to-Talk; requires BDN6676D audio adapter
- RLN5312A** Black Two-Wire Comfort Earpiece with Combined Microphone and Push-to-Talk; requires BDN6676D audio adapter
- RLN5313A** Receive-Only Comfort Earpiece, black
- RLN5314A** Receive-Only Comfort Earpiece, beige

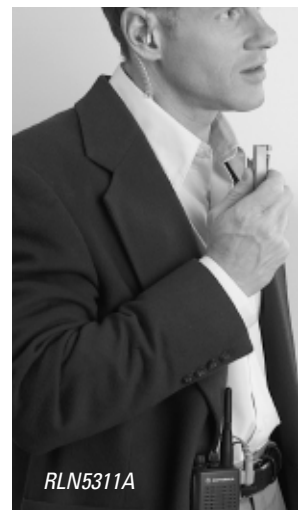

* Intrinsicly safe

HT1000 Series



Portable Accessories

Audio Accessories

Completely Discrete Earpiece

Remain discretely in touch with this miniaturized receiver. All messages received through the user's two-way radio are inductively relayed to the wireless earpiece in the user's ear. Inductive neckloop is easily hidden under the user's clothing for covert operations. Neckloop attaches to the user's Motorola Surveillance Kit providing completely discrete two-way communications. Security operatives, public safety officials, and private investigators can communicate with ease without any visible equipment. Small as it is, it offers a full range of audio functions including automatic squelch, automatic gain control and noise filtering. Must be used in conjunction with a Motorola Surveillance Kit. Just remove the earpiece on any standard 2- or 3-wire surveillance kit and plug in the neckloop for completely discrete communication.

RLN4922A Completely Discrete Earpiece Kit; includes wireless earpiece, inductive neckloop, 6 spare batteries and 5 spare ear wax guards

RLN4919A Ear Wax Guards, 5 per pack

RNN4005A 1.4V Battery, 6 per pack



RLN4922A

Audio Accessories

Noise Kits

Lightweight translucent tube attaches to Motorola surveillance accessories. Clothing clip prevents the accessory from being pulled from the ear due to body movement or head rotation.

NTN8370A Extreme Noise Kit, includes 2 foam earplugs for loud environments, provides 24dB noise protection

NTN8371A Low Noise Kit, includes rubber eartip for low noise environments

5080384F72 Replacement Foam Plugs; pack of 50 (for use with NTN8370A)

5080371E73 Replacement Standard Rubber Eartips; pack of 25 (for use with NTN8371A), beige



NTN8370A

Clear Comfortable Earpiece

The clear comfortable earpiece forms to the inside of your ear and is perfect for low noise environments. Compatible with the NTN8371A, clear acoustic tube assembly, and most surveillance kits (1-, 2- and 3-wire). This earpiece is made of easy-to-clean chemically inert, hypoallergenic material. There are 3 items needed to make this product work:

1. Clear Comfortable Earpiece
2. Clear Acoustic Tube Assembly (NTN8371A)
3. Surveillance Kits

RLN4760A Small Custom Earpiece, right ear

RLN4763A Small Custom Earpiece, left ear

RLN4761A Medium Custom Earpiece, right ear

RLN4764A Medium Custom Earpiece, left ear

RLN4762A Large Custom Earpiece, right ear

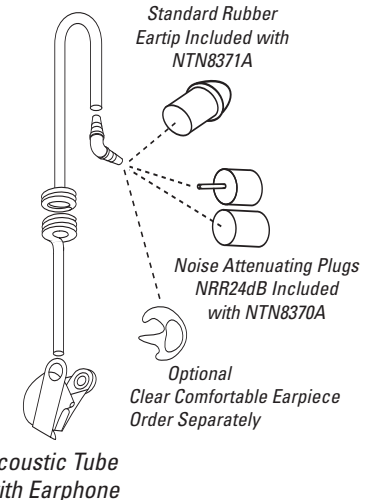

HT1000 Series

Portable Accessories

Audio Accessories

Ear Microphone System (EMS)

This compact unit picks up the voice through bone vibrations in the ear canal. The miniature earpiece leaves the hands free and face unobscured when worn by rescue and hazard protection personnel, who still retain the ability for direct hearing and speaking. For personnel required to wear breathing apparatus, communications with protective masks are as clear as communications without. And its high speech clarity under noisy environments makes it ideal for high noise environments. Available in PTT or Voice Activated (VOX).

Interface Module needs to be ordered separately for EMS to work.

***BDN6677A** Ear Microphone for Standard Noise Levels (up to 95dB, black)

***BDN6678A** Ear Microphone for Standard Noise Levels (up to 95dB, beige)

***BDN6641A** Ear Microphone for High Noise Levels (up to 105dB)



BDN6708B

Interface Module For EMS

***BDN6708B** Push-To-Talk Interface Module

***BDN6671B** Push-To-Talk or Voice-Activated Interface Module

Audio Accessories

Optional Accessories For EMS

***0180358B38** Remote Push-To-Talk Ring Switch

0180300E83 Remote Push-To-Talk Body Switch

0180300E25 Earguard with Adjustable Loop; secures ear mic in ear



0180358B38

0180358B32 Earholder, black size small; secures ear mic in ear

0180358B33 Earholder, black, size medium; secures ear mic in ear

0180358B34 Earholder, black, size large; secures ear mic in ear

0180358B35 Earholder, clear, size small; secures ear mic in ear

0180358B36 Earholder, clear, size medium; secures ear mic in ear

0180358B37 Earholder, clear, size large; secures ear mic in ear



0180358B33

4280369E44 Replaceable Belt Clip with Screws

5080358B28 Eartips, black, size medium (10 per pack)

5080358B29 Eartips, black, size large (10 per pack)

5080358B30 Eartips, beige, size medium (10 per pack)

5080358B31 Eartips, beige, size large (10 per pack)

Flexible Ear Receiver

The flexible ear receiver contains a flexible earloop and speaker, and rests external to the ear.

BDN6719A Ear Receiver with 3.5 mm Threaded Plug, requires adapter BDN6676D unless being used with speaker microphone

7580372E11 Replacement Foam Ear Cushions for BDN6719A



BDN6719A

* *Intrinsically safe*

HT1000 Series

Portable Accessories

Audio Accessories

Pellet Style Earpieces

BDN6780A Single Earbud with Microphone and Push-To-Talk, requires adapter BDN6676D, unless being used with speaker microphone

BDN6781A Single Earbud, receive only; requires adapter BDN6676D unless being used w/speaker microphone

7580372E70 Replacement Foam Ear Cushion for Pellet Earpieces



BDN6780A

Lightweight Headsets

Lightweight headsets allow for high clarity, hands-free, discrete two-way communication, while adding comfort necessary for extended wear in moderate noise environments. Requires BDN6676D Audio Adapter.

***NMN6245A** Single Muff Adjustable Lightweight Headset with Boom Microphone and In-line Push-To-Talk Switch (requires BDN6676D adapter)

***NMN6246B** Ultralite Headset with Boom Microphone and In-line Push-To-Talk Switch; ear bud style receiver (requires BDN6676B adapter)

***NMN1020A** Lightweight Headset with Boom Microphone to be worn on a helmet or safety glasses. Includes NKN6498A adapter cable. Requires BDN6676D adapter. FM approved.

***NKN6498A** Headset Adapter Cable for use with NMN1020A

REX4648A Replacement Foam Earpad and Windscreen Kit for NMN6245A

5080574E02 Foam Earpads for use with NMN6245A, 10 per pack

Audio Accessories

Temple Transducer

The Temple Transducer represents a significant achievement in headset design and functionality. It allows the user to receive audio without covering the ear. The receiver portion of the accessory rests on the temples and it is capable of converting the receive audio from a two-way radio into sound vibration. The sound vibration is transmitted through the surrounding human tissue and bone directly into the inner ear where it is received by the user. It features an in-

line PTT and noise canceling boom microphone. The Temple Transducer enhances communications and safety by not impairing the user's hearing of external sound environment, such as from machinery and equipment, warning and fire alarms, the intercom, traffic, and even casual conversations with their co-workers.

***RMN4049A** Temple Transducer



RMN4049A

Racing Headset

Motorola is the Official Wireless Equipment supplier of CART, so whether your customers' playing field is a racetrack, construction site or other challenging environment, they can count on this Racing Headset for superior comfort and dependable operation.

RMN5015A Racing Headset (Requires radio adapter cable BDN6673B)



RMN5015A

* Intrinsicly safe

HT1000 Series

Portable Accessories

Audio Accessories

Medium Weight Headsets

Medium Weight Headsets offer high-clarity sound with the additional hearing protection necessary for providing consistent, clear two-way radio communications in harsh, noisy situations.

***NMN6258A** Medium Weight Headset, over the head with In-Line PTT, Noise Reduction Rating = 24dB

***NMN6259A** Medium Weight Headset, behind the head with In-Line PTT, Noise Reduction Rating = 24dB

7580376E34 Replacement Foam Earseals, 1 pair

1580376E32 Replacement Cloth Covers for Earseals, 1 pair

5080548E02 Replacement Windscreen for Boom Microphone

3280376E35 Replacement "O"-ring for Windscreen

4204004K01 Replacement Adjustable Headstrap for NMN6259A

RMN4051A Hardhat Mount Headset mounts easily to hardhats with slots and provides 22dB of noise reduction; requires RKN4095A adapter cable, hardhat not included

RKN4095A Radio Adapter Cable with In-Line PTT for use with RMN4051A



NMN6258A

Tactical Medium Weight Headsets

Same high-clarity sound and additional hearing protection as our standard medium weight headsets while including two microphones on the outside of each earcup which reproduces the ambient sound back into the headset. Harmful sounds are suppressed to a safe level and low sounds are amplified up to 5 times but never more than 82dB. Includes on/off volume control on ear cups.

RMN4052A Tactical Headband Style Headset, grey; provides 24dB of noise reduction and requires RKN4095A adapter cable



RMN4052A

Audio Accessories

RMN4053A Tactical Hardhat Mount Headset mounts easily to hardhats with slots; provides 22dB of noise reduction and requires RKN4095A adapter cable, hardhat not included

RKN4095A Radio Adapter Cable with IN-Line PTT for use with RMN4051A and RMN4053A

RLN4923A Two Replacement Snap-in Earseals; Recommended replacement interval is once every six months to ensure constant level of attenuation hygiene and comfort for RMN4051A, RMN4052A, and RMN4053A.

Heavyduty Headsets

Heavyduty headsets include noise-cancelling boom microphones and can be worn with or without a hardhat. The Push-To-Talk switch is located on the earcup. The VOX module is contained within the headset on voice activated units. Heavyduty headsets require radio adapter cable BDN6673B, to be ordered separately.



BDN6645A

***BDN6645A** Push-To-Talk Headset with Boom Microphone; requires adapter cable BDN6673B; noise reduction rating=24dB

***BDN6635B** Voice-activated Headset with Boom Microphone; requires adapter cable BDN6673B; noise reduction rating=24dB



BDN6635B



BDN6636B

***BDN6636B** Voice-activated Headset with Throat Microphone; requires adapter cable BDN6673B; noise reduction rating=24dB

***BDN6673B** Radio Adapter Cable

* Intrinsically safe

HT1000 Series

Antennas

Portable Antennas

Flexible Whip Antennas

Antenna has a one-piece finish and steel core for optimal strength and better radiation characteristics. Provides more comfort when radio is worn on the belt.

8505241U05

Flexible Whip, 403-520MHz, 6"

8505241U03

Flexible Whip, 806-870MHz, 7"

8505241U04

Flexible Whip, 896-941MHz, 7"



Helical Antennas

Helical are sturdy and dependable for years of failsafe communication. Each antenna is designed and built to quality standards. The skirt at the base of the connector helps to seal out damaging elements. Connector is made of plated brass material for long life.

8505644V01

Helical, 136-151MHz, 6"

8505644V02

Helical, 151-162MHz, 6"

8505644V03

Helical, 162-174MHz, 6"

8505644V04

Helical, 403-435MHz, 3"

8505644V05

Helical, 435-470MHz, 3"

8505644V06

Helical, 470-520MHz, 3"



Portable Antennas

Dipole Antennas

Dipole molded antennas are injection molded in lasting polyurethane. The wide skirt at the bottom of the connector protects against damaging environmental elements. The dipole antenna is ideal when strong and solid signal clarity is demanded.

NAF4000B

Dipole, 806-869MHz, 8"

8505884R02

Dipole, 896-941MHz, 8"



Wideband Antenna

Wideband antenna is ideal when radio is used in different frequencies since one antenna will cover all ranges.

8505518V01 Wideband, 136-174MHz, 6"

Stubby Antenna

This quarterwave stubby antenna is ideal when radio is worn on the belt because the short antenna is non-obtrusive. This is a broadband antenna that can be used for both 800MHz and 900MHz applications.

8505241U06*

Stubby, 806-941MHz, 4"



*8505241U06 is a broadband antenna that operates in the 800/900 MHz band

HT1000 Series



Miscellaneous Accessories, Batteries

Miscellaneous Accessories

Replacement Kit

REX4398A 2/8/16 Channel Cosmetic Replacement Kit

Public Safety Tilt Switch

An external emergency switch that is activated when the unit is tilted at a greater than 60 degree angle. Delay times are factory programmed for 8 seconds and are not field programmable. The emergency feature must be programmed into the radio to enable the tilt switch option. FM approved. Not compatible with the JT1000.

NTN7660A Public Safety Tilt Switch

Portable Batteries

Nickel-Cadmium Premium

Part Number: **NTN7143CR**
Volts: 7.5
Avg. mAh: 1200
Height: 6"
Intrinsically Safe: No



NTN7143CR

Part Number: **NTN7144CR**
Volts: 7.5
Avg. mAh: 1500
Height: 6"
Intrinsically Safe: No

Part Number: **NTN7146AR**
Volts: 7.5
Avg. mAh: 1200
Height: 6"
Intrinsically Safe: Yes

Part Number: **NTN7147AR**
Volts: 7.5
Avg. mAh: 1300
Height: 6"
Intrinsically Safe: Yes



NTN7147AR

Part Number: **NTN7149BR**
Volts: 7.5
Avg. mAh: 1300
Height: 6"
Intrinsically Safe: Yes
CSA: Yes

Part Number: **NTN7150AR**
Volts: 7.5
Avg. mAh: 1200
Height: 6"
Intrinsically Safe: Yes
MSHA: Yes



HT1000 Series

Batteries, Service Aids

Portable Batteries

Part Number: **NTN7341AR**

Volts: 7.5

Avg. mAh: 1400

Height: 6"

Intrinsically Safe: Yes



NTN7341AR

Part Number: **NTN7372AR**

Volts: 7.5

Avg. mAh: 1200

Height: 6"

Intrinsically Safe: Yes



NTN7372AR

Nickel Metal Hydride Premium

Part Number: **WPNN4013A**

Volts: 7.5

Avg. mAh: 2000

Height: 6"

Intrinsically Safe: No



WPNN4013A

Part Number: **WPNN4037A**

Volts: 7.5

Avg. mAh: 1900

Height: 6"

Intrinsically Safe: Yes

Nickel-Cadmium impres™

Part Number: **HNN9028AR**

Volts: 7.5

Avg. mAh: 1500

Height: 6"

Intrinsically Safe: No

Part Number: **HNN9029AR**

Volts: 7.5

Avg. mAh: 1500

Height: 6"

Intrinsically Safe: Yes

Service Aids

Cloning Cable

Allows another radio to be duplicated from a master radio by transferring programmed data from one radio to another.

RKN4036D Cloning Cable

Radio Interface Box

Links radio programming cable and computer interface together. Provides required voltage shift to enable communications between radio and computer. Requires computer interface cable, radio test and programming cable, and 9 volt snap type battery (6082728J01), order separately.



RLN4008E

RLN4008E Radio Interface Box

Computer Interface Cable

Used to connect computer's serial adapter to Radio Interface Box.

3080369B71 Cable, RIB to 25 pin D

3080369B72 Cable, RIB to 9 pin D



3080369B71

Radio Test and Programming Cable

Used with Portable Radio Test Set, RTX4005B, for transmitter, receiver alignment and performance checks. Also used in programming radio.

RKN4035D Radio Test and Programming Cable

Wall Mounted Power Supply

Used to supply power to radio interface box RLN4008E

0180357A57 Wall Mounted Power Supply, 110 Volts

0180358A56 Wall Mounted Power Supply, 220 Volts



0180357A57

HT1000 Series

Service Aids, Manuals

Service Aids

Battery Eliminator

RLN1014A The Battery Eliminator acts like a battery with a cable to access a DC external power supply. It is ideal to inspect transmitters and receivers on incoming radios. Reverse supply polarity protection and input fuse protection are provided.



RLN1014A

Programming Software

Utilizing your personal computer, this software enables you to add or reprogram frequencies as your requirements change. Requires interface box and appropriate cables, must be ordered separately.

RVN4098H Programming Software

Option Boards

NTN8313A Analog Voice Scrambler Advantage Board, for use with HT1000 only. *NOT APPROVED* for installation in FM approved models.

Manuals

6881200C15	HT1000/JT1000/MT2000 & MTX8000/9000 Radio Theory
6881200C40	HT1000/JT1000 & MT2000 Service Manual
6881200C25	MTX8000/9000 Service Manual
6881079C50	HT1000 Operator's Manual
6881078C45	JT1000 Operator's Manual
6881076C65	MT2000 Operator's Manual
6881072C10	MTX8000/9000 B3 Operator's Manual
6881072C40	MTX8000/9000 B5/B7 Operator's Manual
0180305J46	Ear Microphone System and Temple Transducer CD-ROM
0180305J70	impres™ System CD-ROM

Over 7 million customers have made MyRadioMall.com America's #1 choice when it comes to dependable and reliable Motorola Communications at fantastic prices.

We are now celebrating our 12th year of online service and the best is yet to come.



Advanced Radio Systems, Inc
8726 NW 26 Street #6
Miami, Florida 33172
Voice Numbers: 305-884-1795
Toll Free: 1-866-900-Mall (6255)
Fax Number: 305-884-1985

12/25/2006